



WHIPPLE **SUPERCHARGER** INSTALLATION MANUAL

2024 FORD 5.0L F150

PART NUMBERS: WK-2317-STG1-30, WK-2317-STG1R-30, WK-2317-STG2-30, WK-2317-STG1-30D, WK-2317-STG1R-30D, WK-2317-STG2-30D, WK-2316-S1-32, WK-2317-STG1R-32, WK-2317-STG2-32, WK-2317-STG1-30D, WK-2317-STG1R-30D, WK-2317-STG2-30D, WK-2317-STG1-32D, WK-2317-STG1R-32D, WK-2317-STG2-32D, WK-2317-TUS-S130, WK-2317-TUS-S230, WK-2317-TUS-S132, WK-2317-TUS-S232, WK-2317-SAL-S130, WK-2317-SAL-S230, WK-2317-S132, WK-2317-S232



WHIPPLE SUPERCHARGERS

3292 NORTH WEBER AVE

FRESNO, CA 93722

TEL 559.442.1261

FAX 559.442.4153

WWW.WHIPPLESUPERCHARGERS.COM

PREMIUM FUEL ONLY (91 OCTANE OR BETTER ALWAYS) RON+MON/2

CALIFORNIA AIR RESCOURCE BOARD EXECUTIVE ORDER #D-231-110

COMPETITION BASED PRODUCT MAY BE USED SOLELY ON VEHICLES USED IN SANCTIONED COMPETITION WHICH MAY NEVER BE USED UPON A PUBLIC ROAD OR HIGHWAY

INTRODUCTION

Before beginning installation, please read this manual and important notes:

- Please read the installation manual and verify that all items are present. If you are missing hardware or have any questions, please contact your dealer or Whipple Superchargers before you start the installation.
- Premium fuel (US 91 octane) is required to prevent spark-knock/detonation under certain operating conditions. Other countries must meet US 91 octane standards, RON+MON/2. **If fuel of less than 91-octane is present in the vehicle fuel tank, the tank must be completely drained and refilled with 91 or higher octane to 1/8th of a tank. The fuel system is returnless, therefore, initial fuel in the system will be low octane. Drain all fuel!**
- Operating your engine without the Whipple Calibration can result in engine damage or failure and will void your warranty.
- Supply your VIN number (along with gear ratio, transmission type, throttle body type and any changes to vehicle) to Whipple ahead of SC installation so your PCM calibration can be built prior to the SC installation to minimize any down time. **NOTE:** Whipple does not support long tube headers or cat removal. While the vehicle may run correctly, it will no longer be emissions legal and therefore not supported.
- Instructions reference **LH** (Left Hand) and **RH** (Right Hand) side of vehicle. This is if you're sitting in the driver's seat facing forward.
- **NEVER MANUALLY MOVE THE BYPASS ACTUATOR, YOU CAN RUPTURE THE INTERNAL DIAPHRAM.**
- **COMPETITION BASED PRODUCT MAY BE USED SOLELY ON VEHICLES USED IN SANCTIONED COMPETITION WHICH MAY NEVER BE USED UPON A PUBLIC ROAD OR HIGHWAY, UNLESS PERMITTED BY SPECIFIC REGULATORY EXEMPTION (VISIT THE "EMISSIONS" PAGE AT [HTTP://WWW.SEMASAN.COM/EMISSIONS](http://www.semasan.com/emissions) FOR STATE-BY-STATE DETAILS.**
- **COMPETITION BASED PRODUCT IS LEGAL IN CALIFORNIA ONLY FOR RACING VEHICLES WHICH MAY NEVER BE USED, OR REGISTERED OR LICENSED FOR USE, UPON A HIGHWAY.**
- **IT IS THE RESPONSIBILITY OF THE INSTALLER AND/OR USER OF THIS PRODUCT TO ENSURE THAT IT IS USED IN COMPLIANCE WITH ALL APPLICABLE LAWS AND REGULATIONS.**

RECOMMENDED TOOLS AND SUPPLIES

The following items are not included in this supercharger kit and it is strongly recommended that they're used for ease of installation or maximum performance:

Engine Oil

Whipple highly recommends running Ford Motorcraft 5W-50 full synthetic motor oil (**PN #XL-5W50-QGT**) vs the stock 5W-20. You will need up to 8 quarts for an oil change along with a Motorcraft oil filter #FL-500.

Tools

¼" and 3/8" torque wrenches. Safety glasses, metric wrench set, electric or air drill, ¼", 3/8", ½" assorted metric socket set, 5mm ball head allen, 3/8" assorted metric allen socket set, 3/8" assorted torx socket set, 8mm hex allen wrench, ½" breaker bar, flat head and Philips screw drivers and drain pan (for coolant). Heat gun or small torch for heat shrinking. Electric tape. Trim pad tool (for pushpin removal). Clean shop towels.

Tie Straps

These will be useful for securing the wiring harness away from the installation area as directed in the instruction manual. They are inexpensive and will be very handy during installation. You will need an assortment of 4", 8" and 12".

Sealants, Chemicals and Lubricants

Anti-seize for bolt and spark plug threads (use only when stated, otherwise the torque value must be reduced). Assembly lubricant (white lithium grease or Lubriplate). Cleaner/degreaser such as carb cleaner. **Blue Loctite #243** or equivalent.

You'll be required to fill your intercooler system with approximately 2 gallons of distilled water and Ford Factory equivalent engine coolant, (50/50 mix only). This is not supplied in the system, you can find the coolant at any local auto parts store. NEVER USE TAP WATER, as it can corrode and create poor performance.

PRE-INSTALLATION CHECKLIST

Before installing your Whipple Supercharger Kit, complete the following checklist.

1. Verify Condition of Vehicle: Before the supercharger kit is installed, ensure the engine runs smoothly and that the factory malfunction indicator light (MIL) is off. Only install the supercharger kit if the engine runs smoothly *and* the MIL is off.
2. **!! CAUTION !!** This product is intended for use only on **STOCK, UNMODIFIED, WELL-MAINTAINED engines**. Installation on a worn-out or modified engine is not recommended and not supported. High mileage-based vehicles (100k+) should be well maintained, up to date on service and change fuel pump assembly to ensure proper fuel flow. Spark plugs with 10,000 miles or more should be changed prior to installing SC (see pre-defined gap instructions).
3. Verify Fuel System: Supercharger systems demand more fuel flow, fuel PSI should be checked post installation to validate proper flow.
4. Assess Cleanliness of Installation Area: Make sure your work area and the under-hood area are free from debris. This supercharger is a high-quality, close-tolerance compressor and must not be subjected to contamination by dirt or any type of foreign material. If necessary, vacuum around engine to remove any foreign material.
5. **!! CAUTION !!** DO NOT remove the protective seal on the supercharger prior to installation. Foreign material entering the supercharger will automatically void all warranties.
6. Identify Supercharger Kit Components: Before beginning installation, identify all the components of your Whipple Supercharger Kit and ensure all items are present and undamaged.
7. **!! CAUTION !!** Do not attempt to start the engine before adding the supplied Supercharger Oil to the supercharger!

SAFETY PRECAUTIONS



CAREFULLY READ THE IMPORTANT SAFETY PRECAUTIONS AND WARNINGS BEFORE PROCEEDING WITH THE INSTALLATION!

Appropriate disassembly, assembly methods and procedures are essential to ensure the personal safety of the individual performing the kit installation. Improper installation due to the failure to correctly follow these instructions could cause personally injury or death. Read each step of the installation manual carefully before starting the installation.

- Always wear safety glasses for eye protection.
- Place the ignition switch in the off position.
- Always apply the parking brake when working on vehicle.
- Block the front and rear tire surfaces to prevent unexpected vehicle movement.
- Operate the engine only in well-ventilated areas to avoid exposure to carbon monoxide.
- Do not smoke or use flammable items near or around fuel system.
- Use chemicals and cleaners only in well-ventilated areas.
- Batteries can produce explosive hydrogen gas which can cause personal injury. Do not allow flames, sparks or flammable sources to come near the battery.
- Keep hands and any other objects away from the radiator fan blades.
- Keep yourself and your clothing away from moving parts when the engine is running.
- Do not wear loose clothing or jewelry that can be caught in rotating or moving parts.

GLOSSARY OF TERMS

ABBREVIATION	DESCRIPTION
DTC	Diagnostic Trouble Code
ECT	Engine Coolant Temperature
EGR	Exhaust Gas Recirculation
ETC	Electronic Throttle Control
EVAP	Evaporative emissions system
FHSCS	Flat Head Socket Cap Screw
IAT	Inlet Air Temperature
IC	Intercooler
ID	Internal Diameter
LB-IN	Pound-force inch
LB-FT	Pound-force foot
LH	Left Hand Side (from driver seat)
LTR	Low temp radiator
MAF	Mass Air Flow
MAP	Manifold Absolute Pressure
MY	Model Year
OBD	On Board Diagnostics
OD	Outside Diameter
PCV	Positive Crankcase Ventilation
PSI	Pound per Square Inch
RH	Right Hand Side (from driver seat)
SC	Supercharger
SHCS	Socket Head Cap Screw
TPS	Throttle Pressure Sensor
TRQ	Torque



****NOTICE:** *Installation of Whipple Supercharger products signifies that you have read this document and have agreed to the terms stated within.*

It's the purchaser's responsibility to follow all installation instruction guidelines and safety procedures supplied with the product as it's received by the purchaser to determine the compatibility of the product with the vehicle or the device the purchaser intends to install the product on.

Whipple Superchargers assumes no responsibility for damages occurring from accident, misuse, abuse, improper installation, improper operation, lack of reasonable care or all previously stated reasons resulting from incompatibility with other manufacturer's products.

There are no warranties expressed or implied for engine failure or damage to the vehicle in any way, loss of use or inconvenience or labor reimbursement. This includes merchantability and fitness.

The information contained in this publication was accurate and in effect at the time the publication was approved for printing and is subject to change without notice or liability. Whipple Superchargers reserves the right to revise the information presented herein or to discontinue the production of parts described at any time.

STOP AND READ BEFORE PROCEEDING



The Whipple Supercharger system is designed to run on premium fuel **ONLY**. Failure to run anything other than 91 or higher (RON+MON)/2 will result in **ENGINE FAILURE** and will **VOID YOUR POWERTRAIN WARRANTY!**

Drain the fuel if any of these five situations are possible. **WARNING!** Draining your fuel means you physically remove the fuel from the vehicle, from the gas tank or fuel rail until empty, not by running vehicle down to low range. Today's vehicles are RETURNLESS, the fuel in the filter, pump and lines will not be returned to tank, thus, your initial fuel delivery will be the fuel that was left in the system from improper draining.

- 1. New vehicles with less than 100 miles. New vehicles are shipped with lower than 87 octane fuel from manufacturer.**
- 2. Any of the last 2 tanks fills had less than 91 or higher octane (RON+MON)/2.**
- 3. Fuel is older than 3 months.**
- 4. Fuel has been mixed between low and high octane.**
- 5. You're not 100% sure of the fuel type and octane.**

SUPERCHARGER INSTALLATION INSTRUCTIONS

It is strongly recommended that you read through this guide before you begin installing the Whipple Supercharger.

1. Follow the supplied flash tool instruction manual for the Whipple Superchargers calibration process. **NEVER START YOUR INSTALLATION WITHOUT HAVING CALIBRATION IN HAND.**
2. Using an air hose, blow off any loose dirt or debris from engine compartment. If dirty, then steam clean the engine compartment before proceeding to the next step.
3. Release the fuel system pressure.

WARNING ⚠ Fuel in the system remains under high pressure even when the engine is not running. Before working on or disconnecting any of the fuel lines or fuel system components, the fuel system pressure must be relieved. Failure to do so can result in personal injury.

WARNING ⚠ Do not smoke or carry lighted tobacco or open flame of any type when working on or near any fuel-related components. Highly flammable mixtures are always present and can be ignited, resulting in personal injury.

- A: Disconnect the Fuel Pump Control Module electrical connector. This is located under the bed, near the spare tire.
B: Start the engine and allow it to idle until it stalls.
C: After the engine stalls, crank the engine for approximately 10 seconds to make sure the fuel injector supply manifold pressure had been released.
D: Turn the ignition switch to the OFF position.
E: Reconnect the fuel pump driver module.

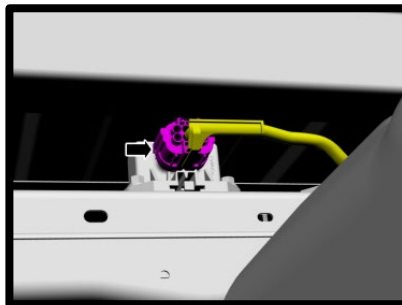

4. Locate the battery on the passenger side of vehicle. With a 10mm wrench disconnect the (-) negative battery cable. Make sure the cable is far enough away from the battery that it does not accidentally touch the battery and make connection during the installation.
5. With a cool engine drain the coolant into a clean drain pan for reuse later. Remove the radiator cap to vent the system. (Be careful not to remove the radiator cap if the engine is still hot). The drain petcock is located on the bottom, driver side of radiator. Loosen spigot and let it drain into pan. Add a 3/8" ID hose to the end of the petcock for cleaner procedure.

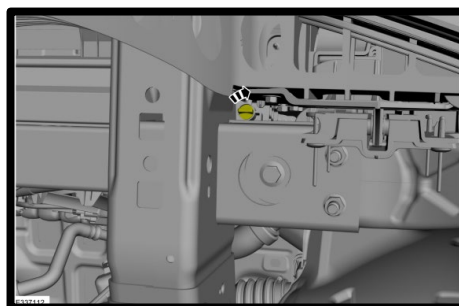

- Lift the front of the vehicle using the Ford recommended lifting points and place on safety stands.
- Remove the factory plastic radiator shroud by pulling the center of the (15x) push pins and then out. Use a flat head screwdriver to pry the center head up. This will all be reused.

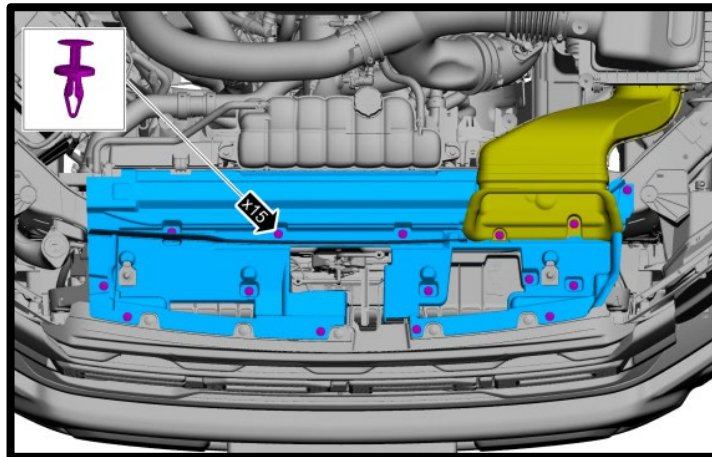

- Disconnect the factory electrical connectors from front grill area when applicable.

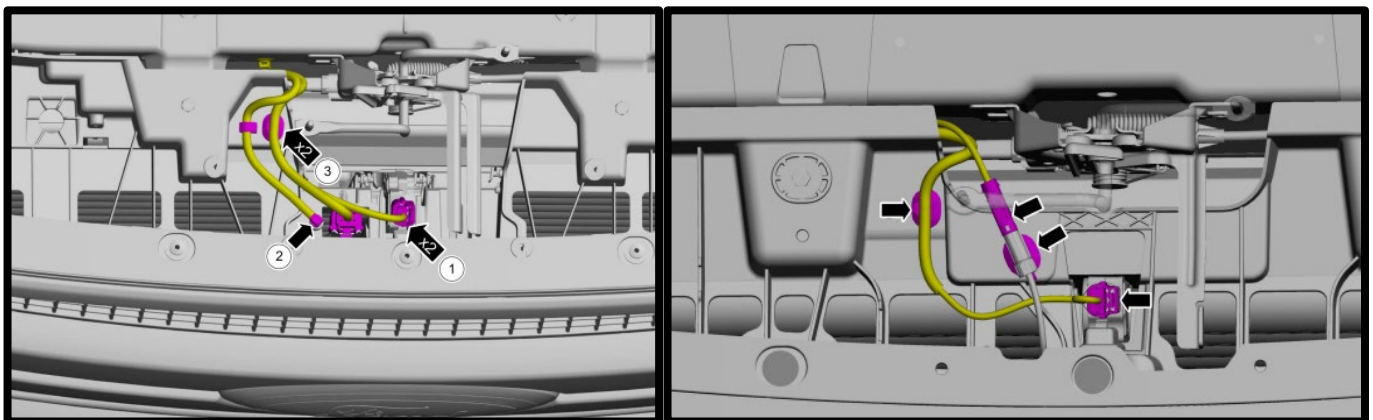

- Remove the (2 per side) push pins from the lower grill shell in the inner fender area. Pull the lower grill shell section from the vehicle.

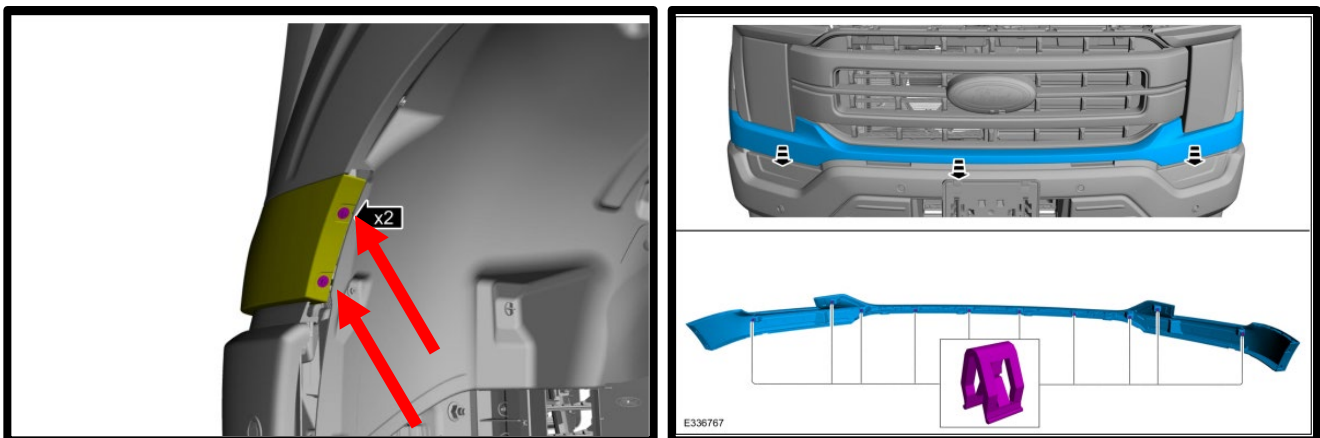

10. Remove the (4x) bolts and (2x) push pin retainers.

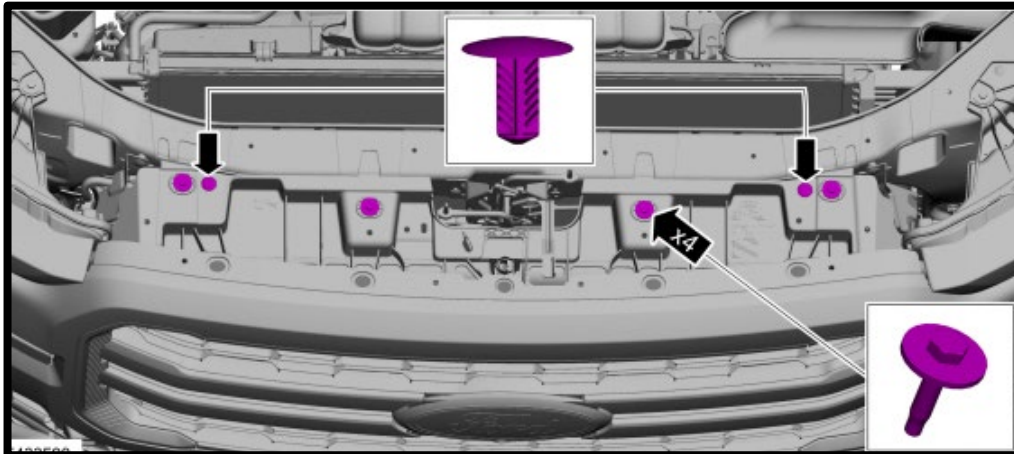

11. (Long Grille) Remove the (2x) push pin retainers.

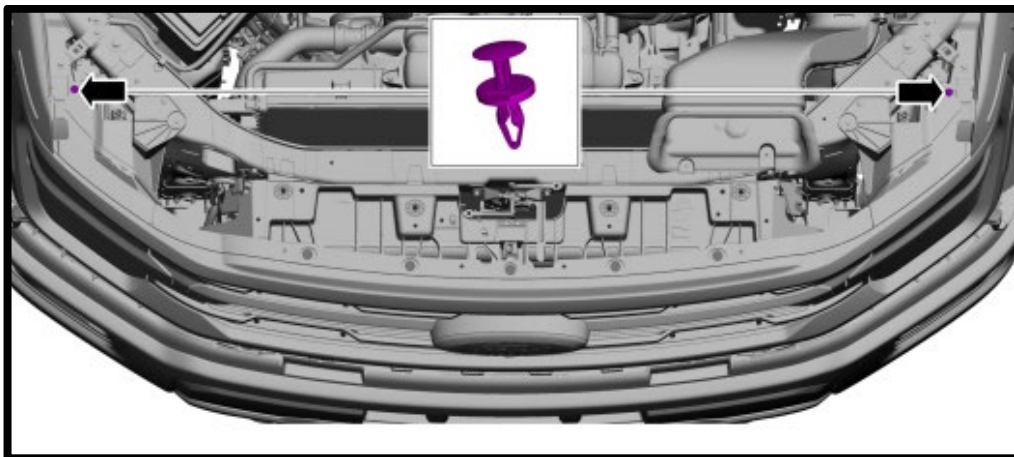

12. (Standard Grille) Remove the (2x) active grille shutter mounting bolts.

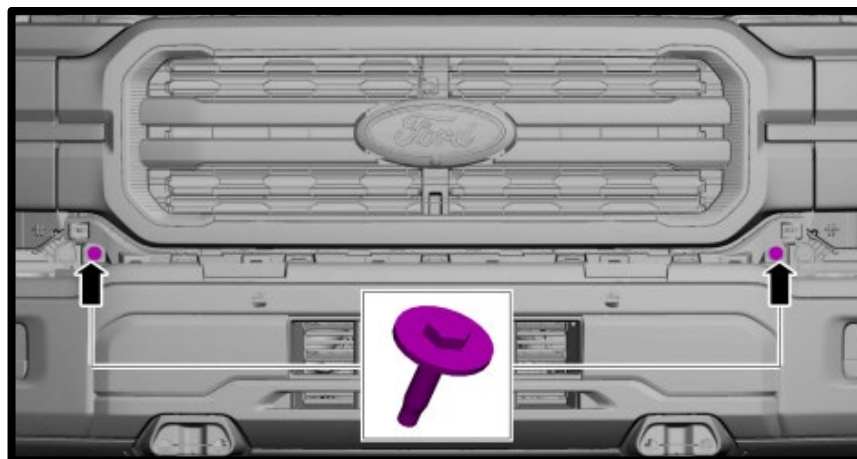

13. (Long Grille) Remove the (2x) active grille shutter mounting bolts.

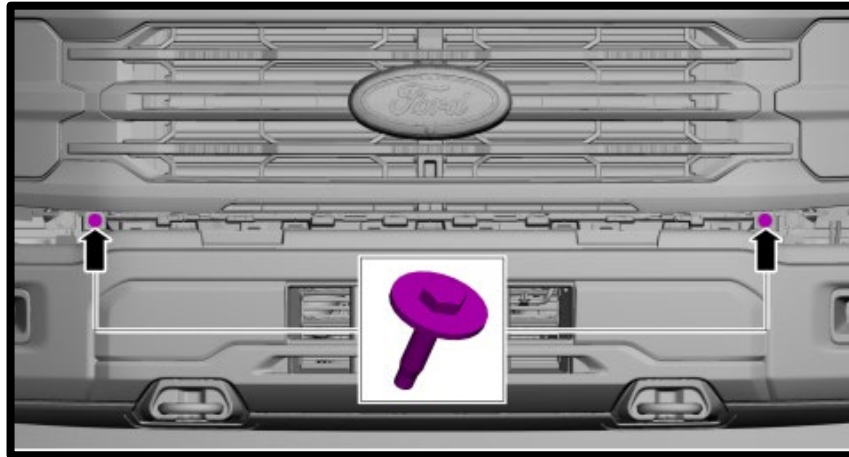

14. (Standard Grille) Pull up and disengage the locating pins along the top of the grill. Pull forward on center of the grill to remove.

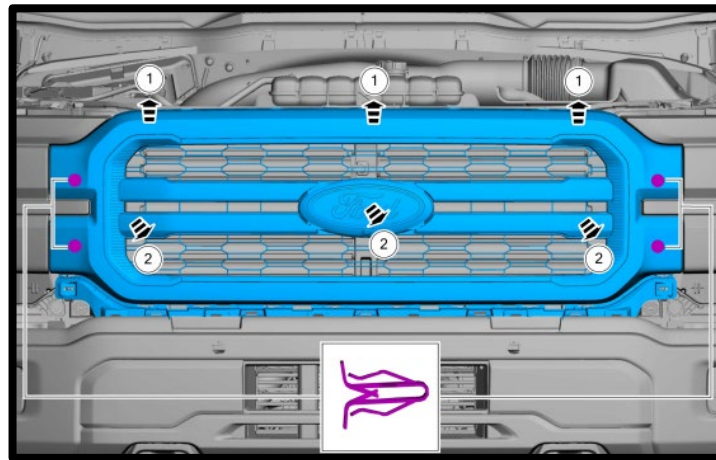

15. (Long Grille) Pull up and disengage the locating pins along the top of the grill. Pull forward on center of the grill to remove.

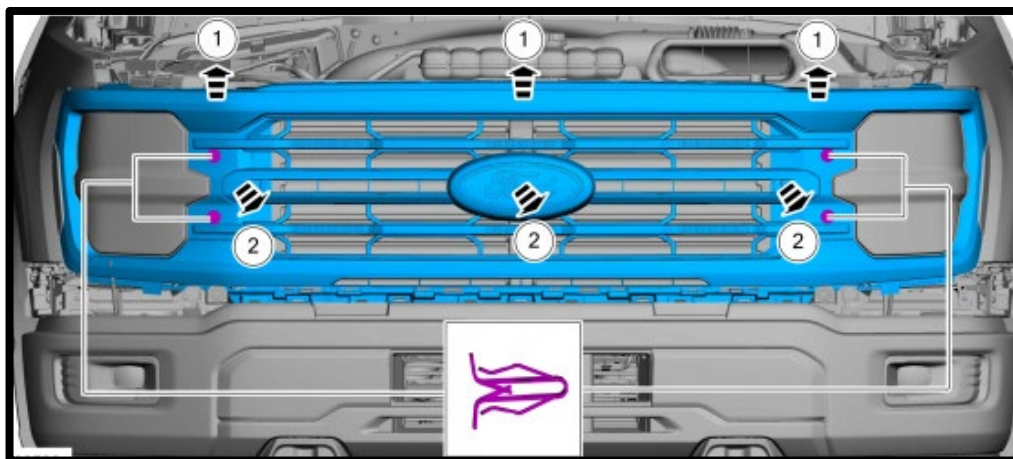

16. Position aside the coolant vent hose from inlet duct. Disconnect the crank case ventilation hose from duct. Loosen the factory hose clamps (2x) securing the inlet duct to throttle body and airbox. Carefully cut the electric tape securing the ETC wires to the throttle body. Disconnect the electronic throttle electrical connector by pushing up on the safety lock and then squeezing the connector and pulling away.

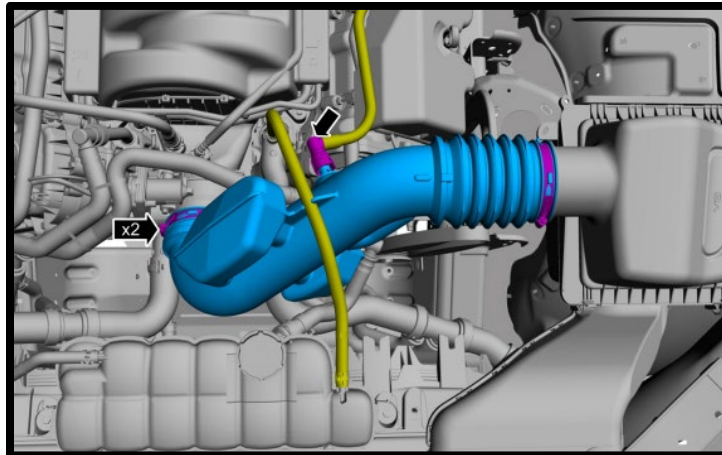

17. Remove the factory make-up air plastic quick connect fitting from inlet duct. This tube will be used later.

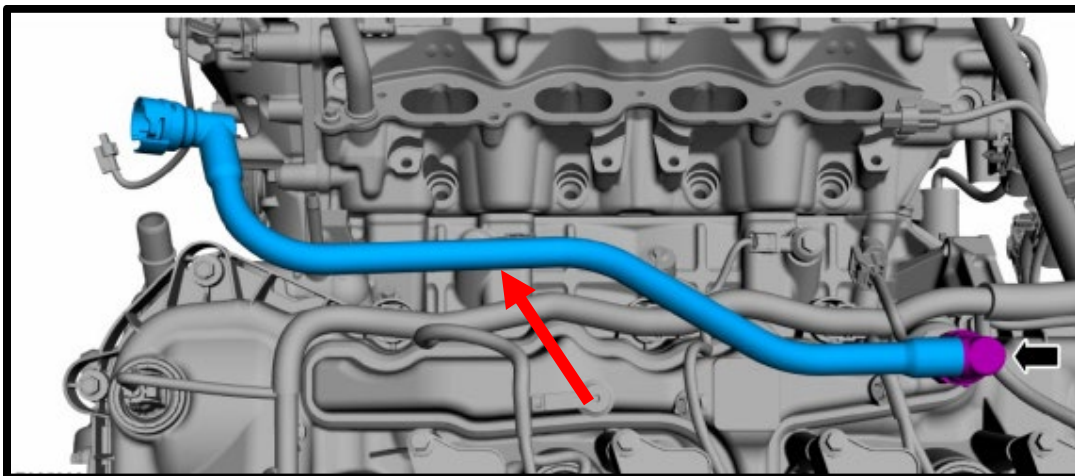

18. Using a 13mm socket, remove the (1x) factory fastener securing airbox to the fender. Using a panel pulley or flat head screwdriver, remove the (2x) push-pins from the factory air snorkel. Remove airbox from vehicle.

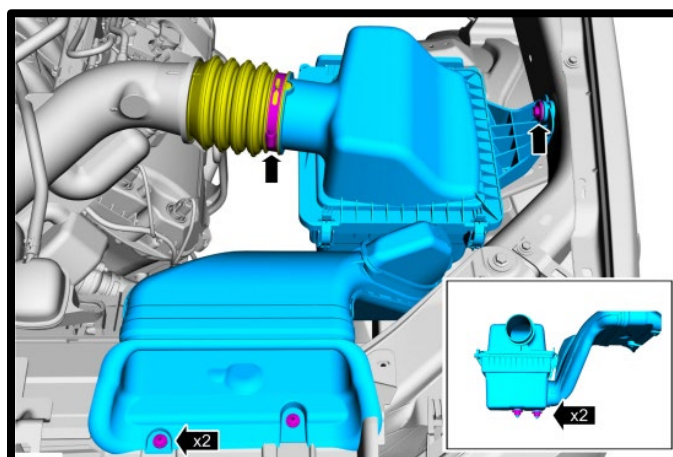

19. Remove the RH side valve cover PCV line from intake manifold and valve cover. This tube will be reused.

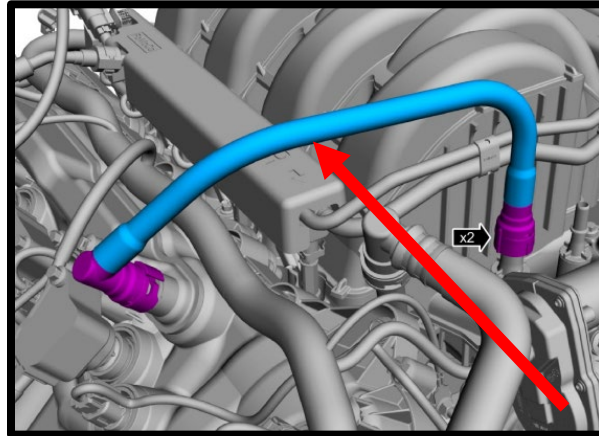

20. Disconnect the EECVP (EVAP) solenoid electrical connector. Disconnect the EVAP solenoid quick connect fitting hose from the EECVP solenoid and from the intake manifold.

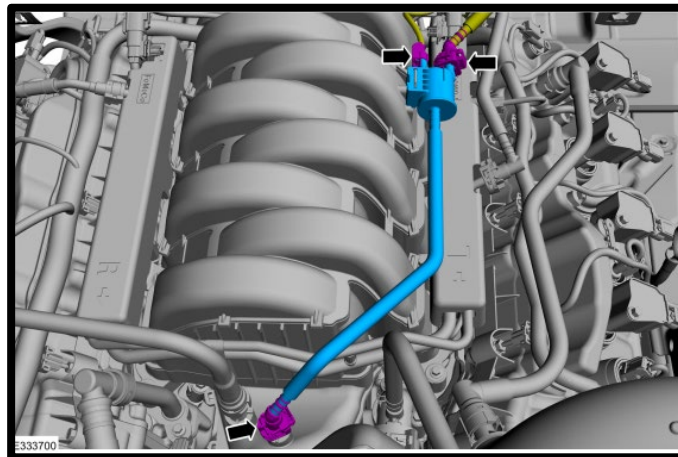

21. Carefully remove the factory fuel line by releasing the safety lock, then squeezing the connector and pulling back. The fuel system may still have pressure, use protective eyewear and multiple rags to catch any possible fuel leak. ***NOTE: THIS FUEL LINE HAS A CHECK VALVE, DO NOT FLIP ORIENTATION. DO NOT REMOVE FROM DI PUMP TO ELIMINATE CONFUSION. 90-DEG END ALWAYS CONNECTS TO FUEL FEED SUPPLY!***

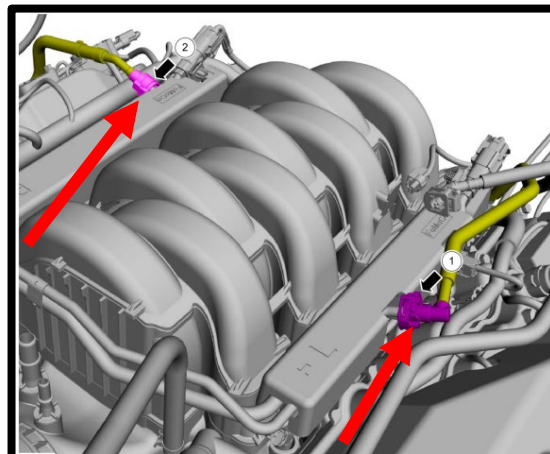

22. Remove fuel rail foam insulation, these will not be reused.

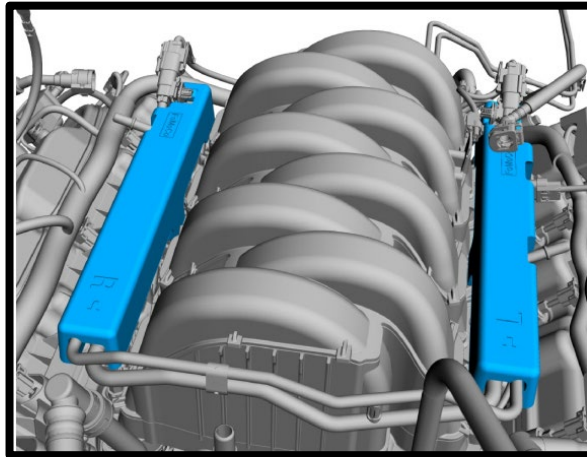

23. Disconnect the (2x) injector harness 6-way pigtails and push connectors out of the way. Remove the fuel PSI sensor electrical connector from the driver side fuel rail by releasing the locking tab and squeezing connector, then pulling away.

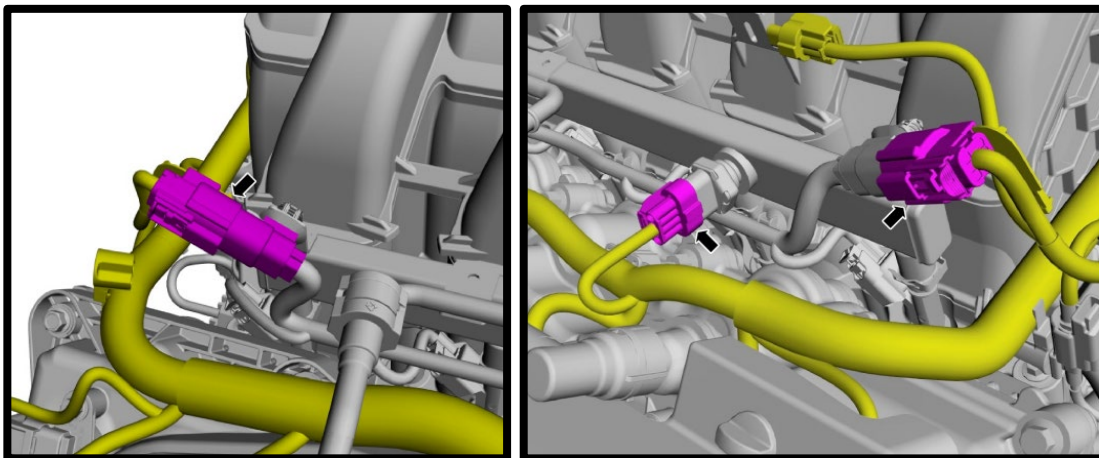

24. Loosen the (4x) bolts holding the fuel rails down, these go through to the cylinder head using a 10mm socket and 6" extension. Fuel rail does not need to be removed yet. Loosen the (8) manifold to cylinder head bolts using an 8mm socket.

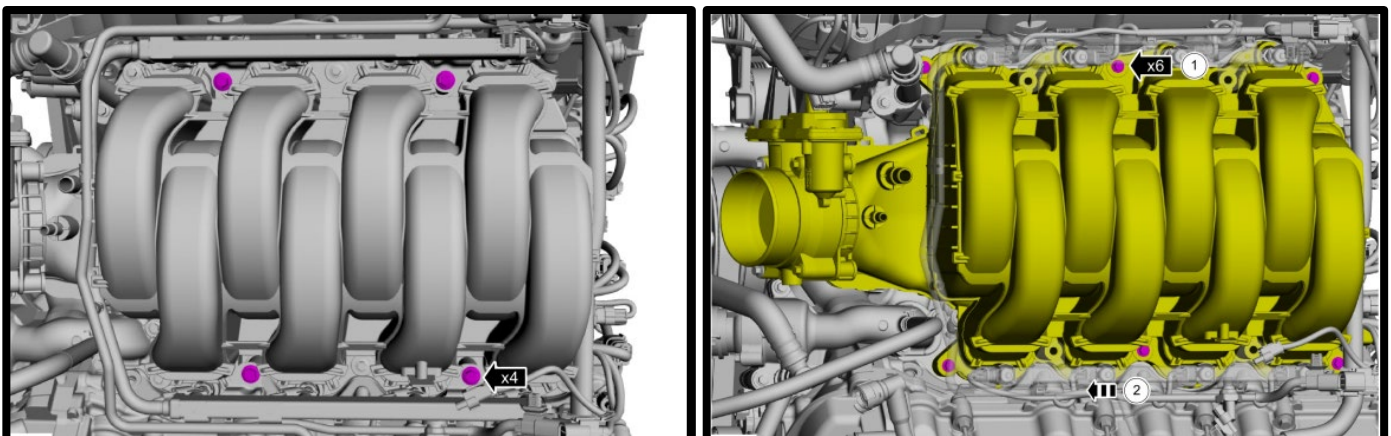

25. Use compressed air and remove any direct or foreign material from cylinder head, block and surrounding area of the fuel rail and injectors. Remove the intake manifold from the engine. To do so, remove the (5x) wire harness push pin supports from the back of the intake manifold and disconnect the 4-way MAP sensor connector. ****DO NOT DISCONNECT DI INJECTOR HARNESS.**

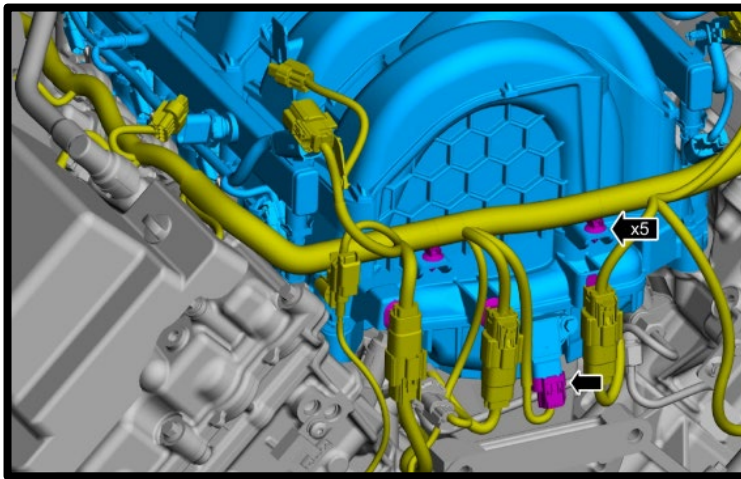

26. Remove the (4x) bolts securing fuel rail to intake manifold. Lift rail up and away from manifold.

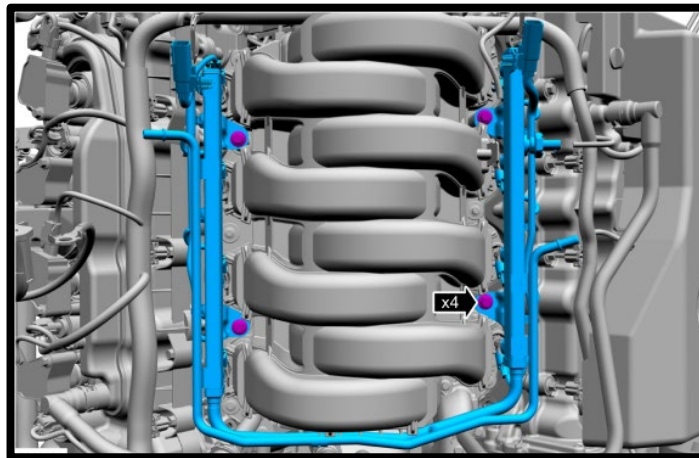

27. Disconnect all (8x) fuel injectors from factory injector harness.

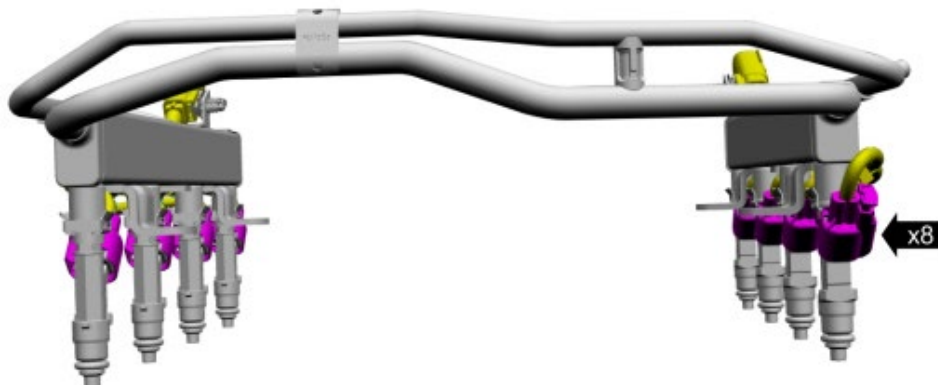

28. **(Stage 1)** Remove the (8x) safety clips from injectors. Remove the injectors from fuel rail. Remove the top and bottom orings from stock injectors. Use Berryman B-12 Carburetor cleaner to clean orings or soak orings for a couple hours in a cleaner such as 409 or similar. If orings have any cuts or damage, replace prior to installing. Once clean, reinstall orings to stock fuel injectors.

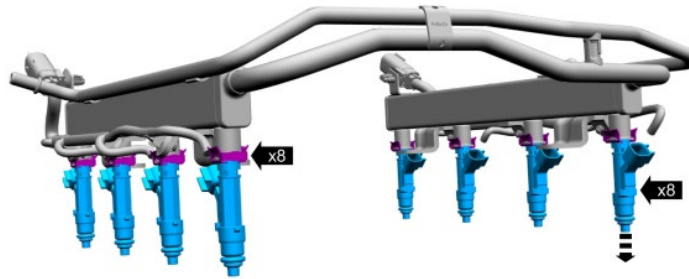

29. Using cutters, remove the clips that secure the injector harness to fuel rail. These clips will not be reused.

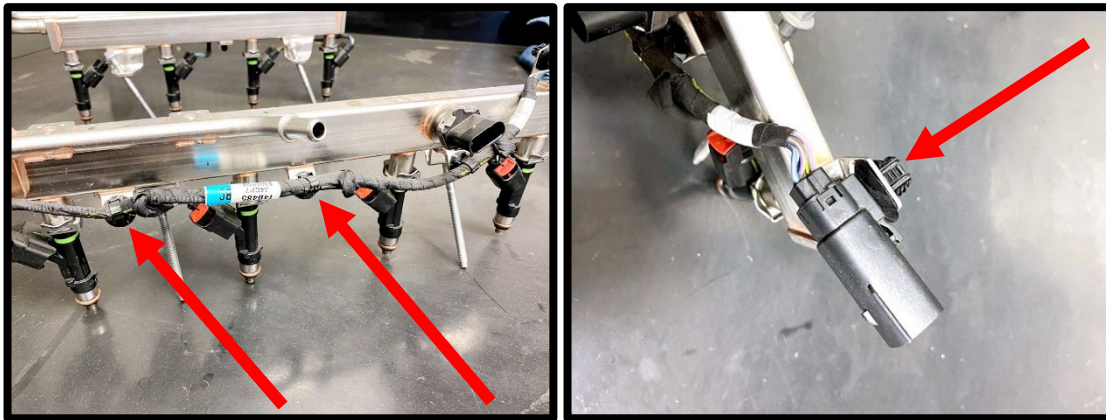

30. Clean the intake manifold to cylinder head surface using carb cleaner or acetone. Install tape over the exposed ports until manifold installation.
31. Using masking tape or similar, wrap around 4-way Temperature Manifold Pressure sensor (TMAP) connector, you will connect the extension to this after SC installation and it will be easier to find.
32. **(Single Alternator)** Remove stock water neck to coolant reservoir vent line from water neck. Remove stock pinch clamp and water neck hose from stock water neck. Using a 10mm socket, remove the (2x) bolts securing stock water neck.

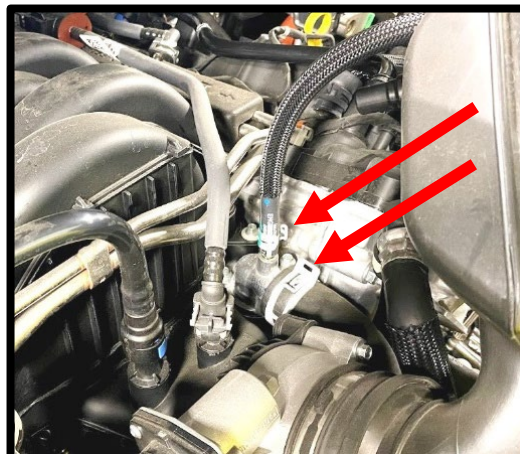

33. **(Single Alternator)** Disconnect the driver side heater tube quick connect fitting by squeezing and lifting away. Remove the heater tube overflow hose using a pinch clamp tool. Using an 8mm socket on the 1 factory bolt, remove the heater tube.

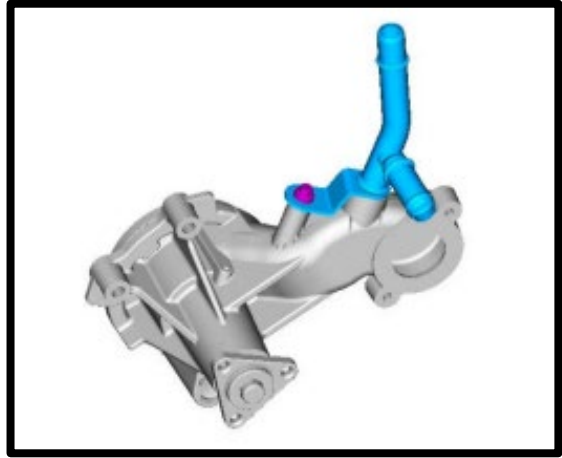
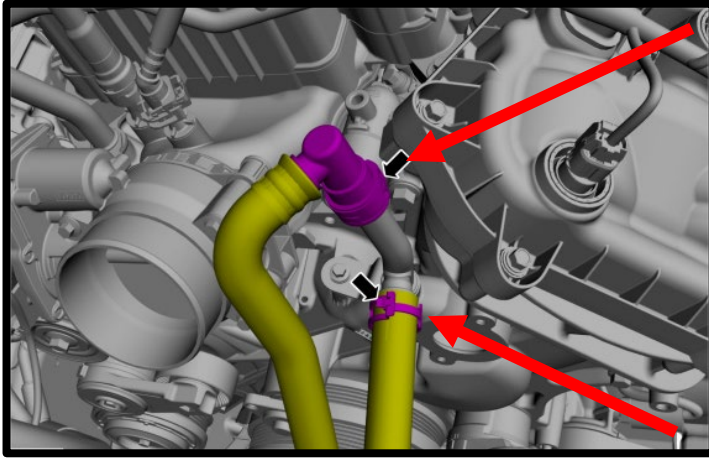

34. Using a cut off saw or similar, remove the plastic molded clamp from the single 3/4" barb of the Y fitting.

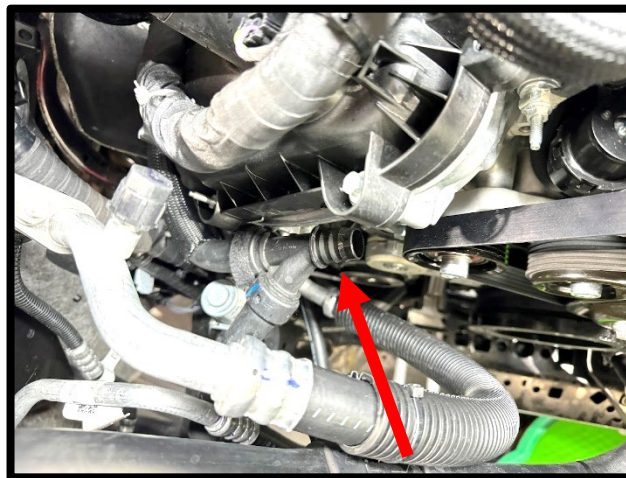

35. **(Single Alternator)** Install the supplied #2-113 oring to the shorter heater tube and install to factory location, secure with stock fastener, torque to 89 lbs-in. Resecure stock heater hose using stock clamp.

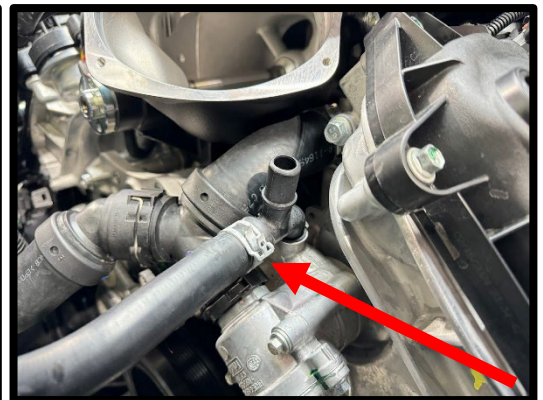
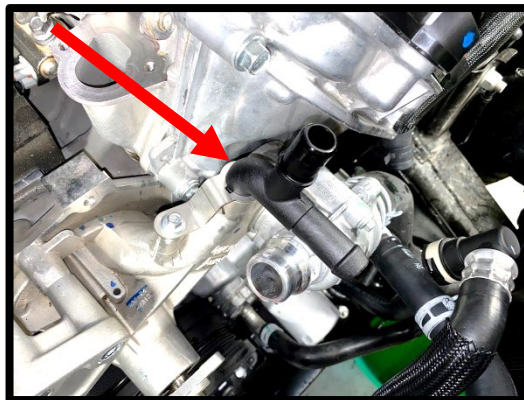

36. Install the supplied U shape heater hose. Secure both ends with supplied (2x) #12 worm clamps.

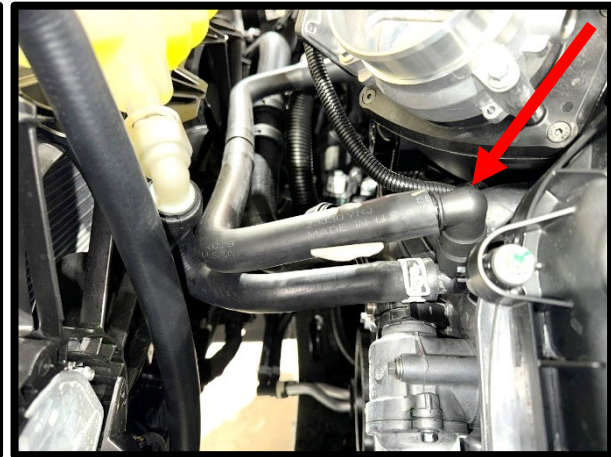
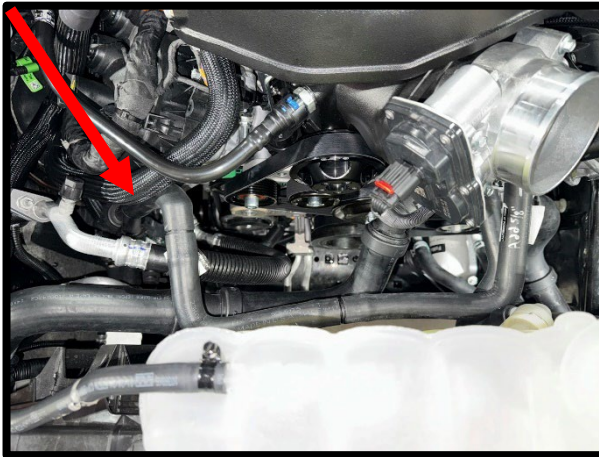

37. **(Single Alternator)** Transfer stock oring from stock water neck to new water neck (clean oring as needed). Apply pipe sealant to threads of 1/8" NPT to 5/16" 45 Deg fitting. Install fitting to water neck, rotate so it ends facing directly towards driver side. Install water neck to motor using stock fasteners (10mm socket), torque to 89 lbs-in.



38. **(Single Alternator)** Reinstall water neck hose with supplied (1x) #24 hose clamp to new water neck.

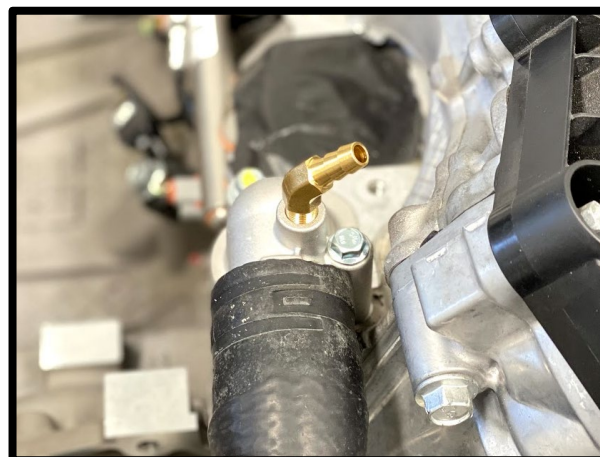

39. **(Dual Alternator)** Release the (3x) factory clamps from thermostat housing coolant lines. Pull hoses away.

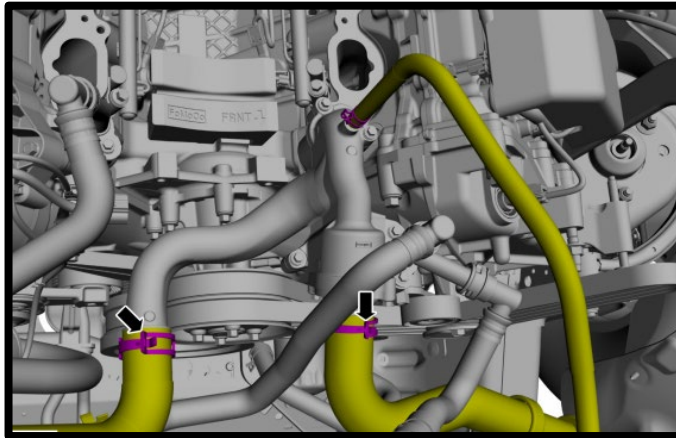

40. **(Dual Alternator)** Release the (2x) coolant lines from the factory LH heater tube.

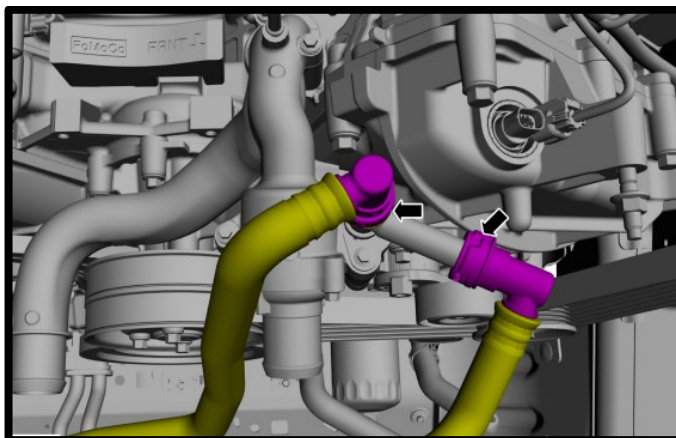

41. **(Dual Alternator)** Remove the (5x) bolts from thermostat housing using a 10mm socket.

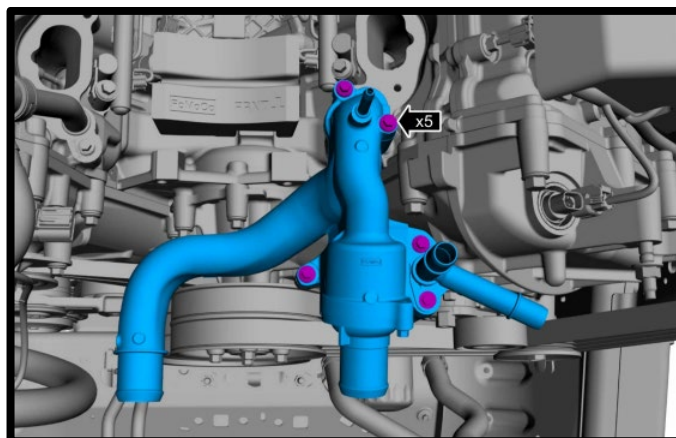

42. **(Dual Alternator)** Visually inspect factory orings from thermostat housing. Transfer to new thermostat housing.

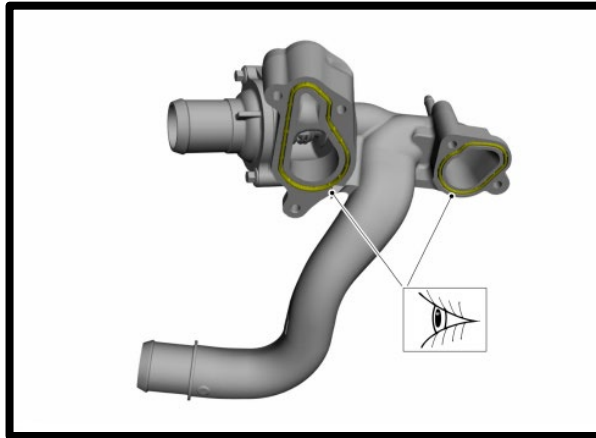

43. **(Dual Alternator)** Remove the (2x) fasteners from the coolant inlet connector, remove inlet connector, thermostat oring and thermostat. Inspect oring, replace if necessary.

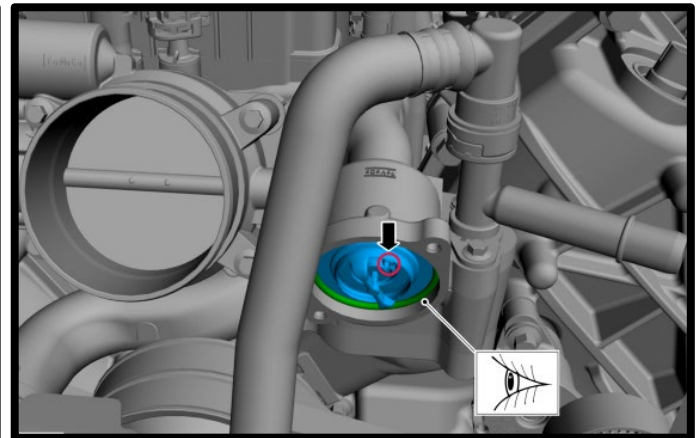
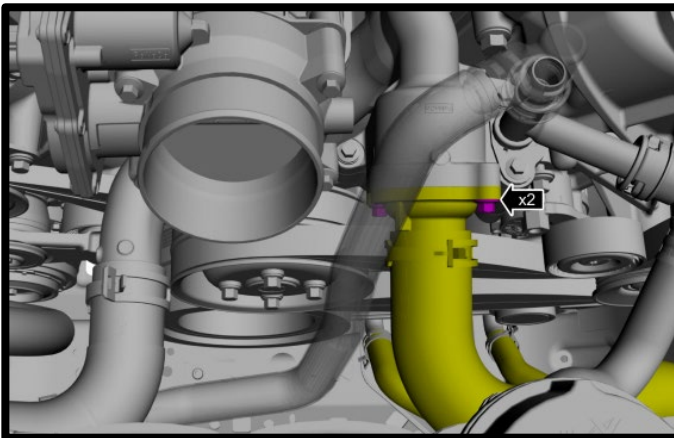

44. **(Dual Alternator)** Install the factory thermostat and thermostat oring to new housing. Install coolant inlet using the factory (2x) bolts. Torque to 89 lbs-in.



45. **(Dual Alternator)** Apply pipe sealant to threads of supplied 1/8" NPT to 5/16" barbed fitting, install to open 1/8" port on housing.



46. **(Dual Alternator)** Install the new thermostat housing assembly to engine using (3x) of the factory fasteners, leave hand tight for now.

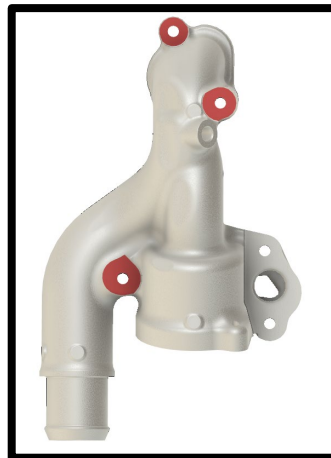
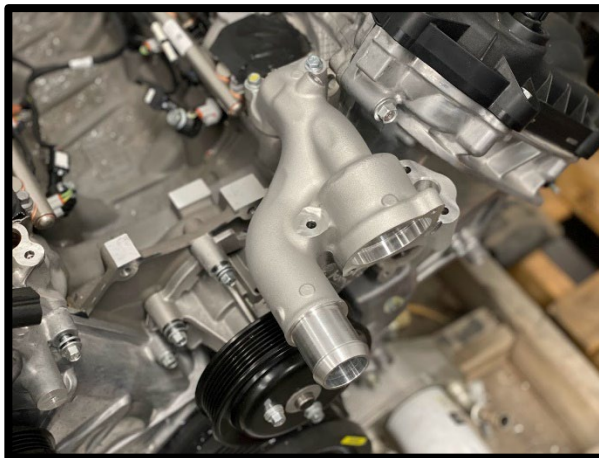

47. **(Dual Alternator)** Install the supplied #2-113 oring to new coolant tube. Install tube to thermostat housing. Secure coolant tube using the (2x) 6mm x 50mm HHFCS bolts supplied. Torque all (5x) thermostat housing bolts to 89 lbs-in.

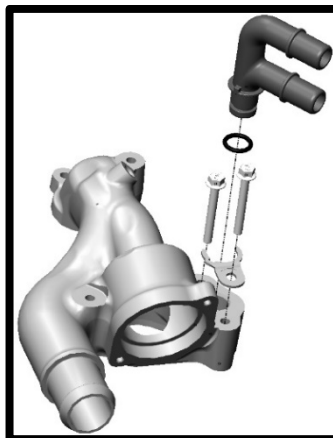
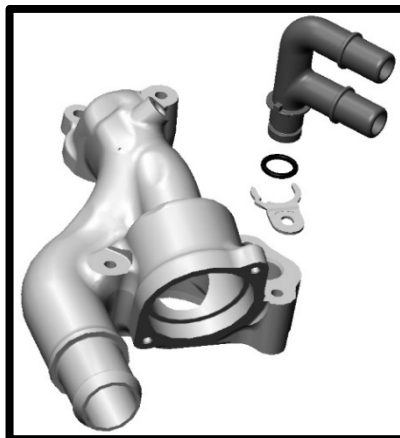

48. **(Dual Alternator)** Remove the factory radiator hose from the radiator and water neck. Replace hose with supplied hose, using stock hose clamps. **NOTE:** Some vehicles are equipped with a Tee fitting for transmission cooler. Remove the plastic clamp from the LH side of the stock tee. Install the supplied radiator hose to water neck fitting, secure with stock clamp. Cut supplied radiator hose to fit factory tee fitting, secure with supplied heat shrink clamp. Use a heat gun on high, constantly moving heat gun until shrink is complete. Let cool for 5 minutes. Slide OEM sheaving over coupler.

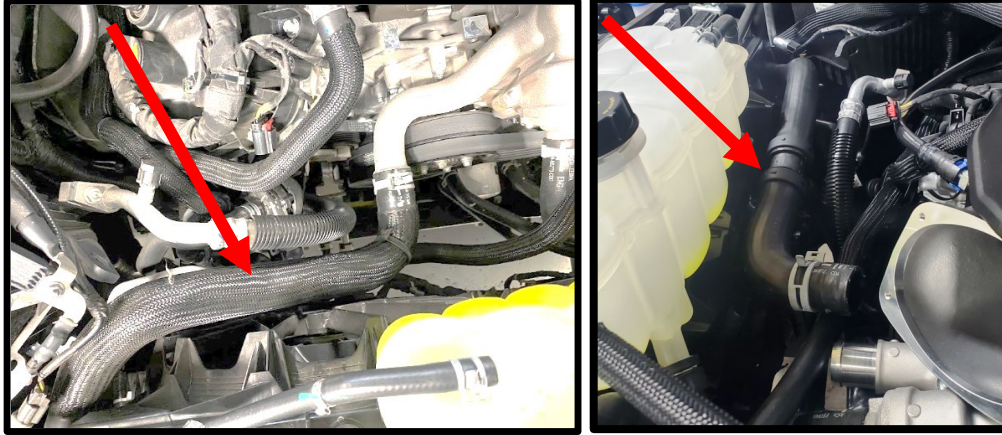

49. **(Dual Alternator)** Reconnect factory quick connect fittings to new coolant tubes.

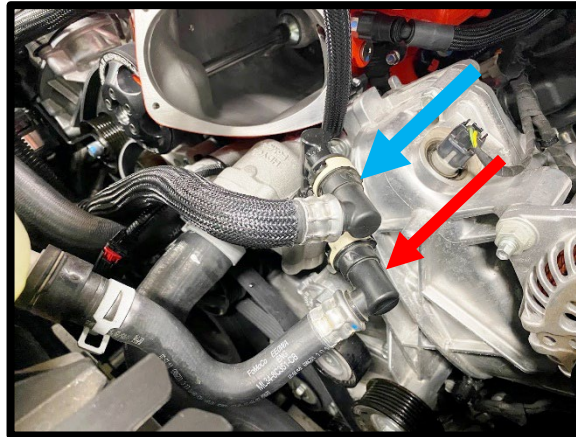

50. **Remove the (8) ignition coils from engine. Using a gapping tool, validate supplied plug gap to be .032". NEVER** adjust with feeler gauge or similar in plug while adjusting, this can damage the fine wire. Install the gapped plugs. Apply light amount of anti-seize to threads. Torque spark plugs to 128 lbs-in. Reinstall the coils on plugs and torque bolts to 97 lbs-in. **WARNING: Plugs are good for a MAXIMUM of 20,000 miles, replace with new Ford Performance M-12405-50VDE only. Failure to do so may lead to failure.**

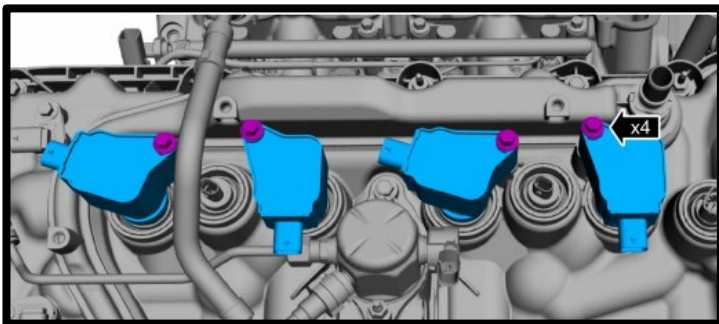

51. Loosen the (3x) bolts securing the water pump pulley using a 10mm socket (while belt is on). Remove the belt from the engine by using a 15mm socket on a 1/2" breaker bar and rotating the spring-loaded tensioner in a clockwise direction. Remove water pump pulley using a 10mm socket (this will be reused).

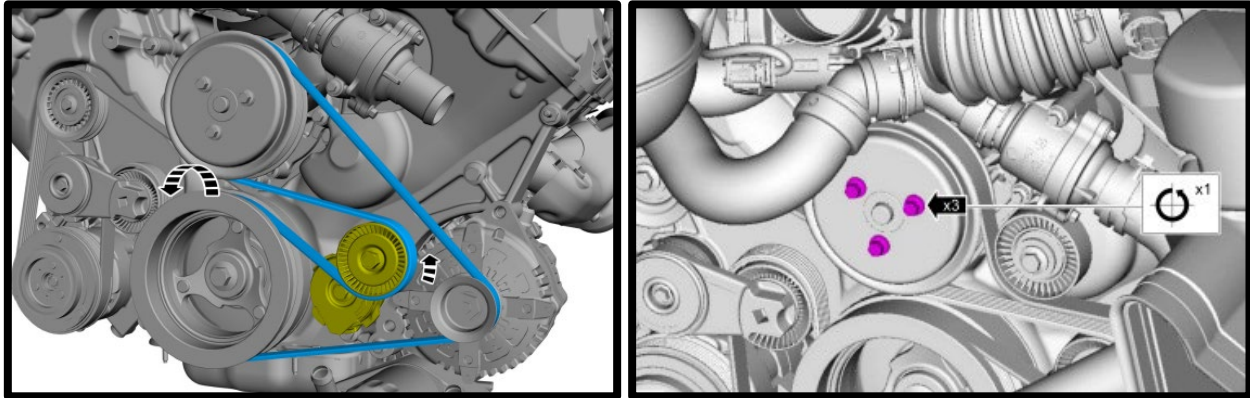

52. Using a 10mm socket, remove the (3x) factory fasteners from the timing chain to head cover and (1x) from water pump (for new idler plate).

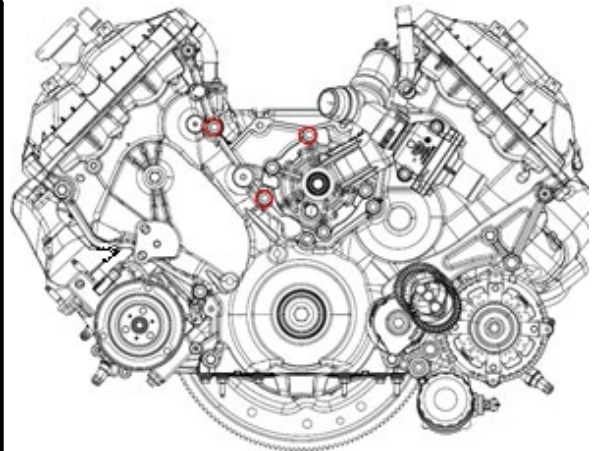
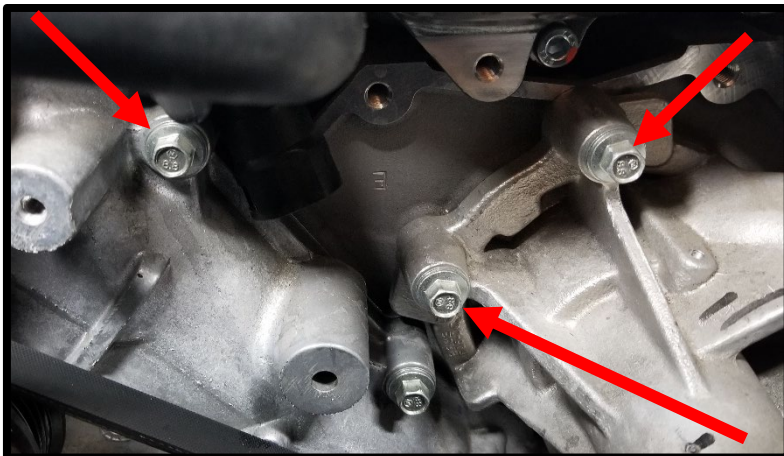

53. Use the supplied (3x) 8mm x 90mm SHCS to secure the idler plate to the engine. Using a 6mm allen, torque to 22 lbs-ft.

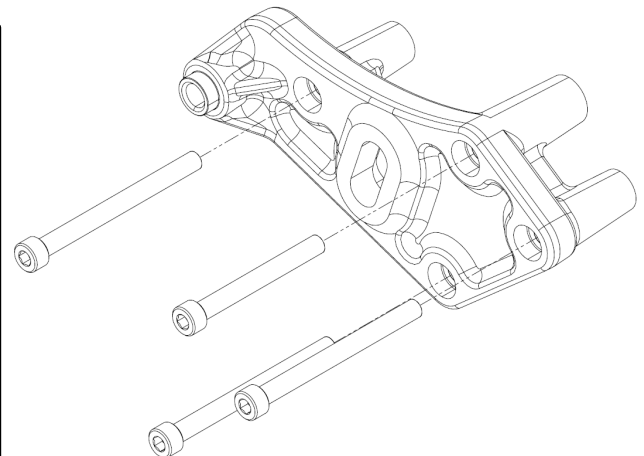
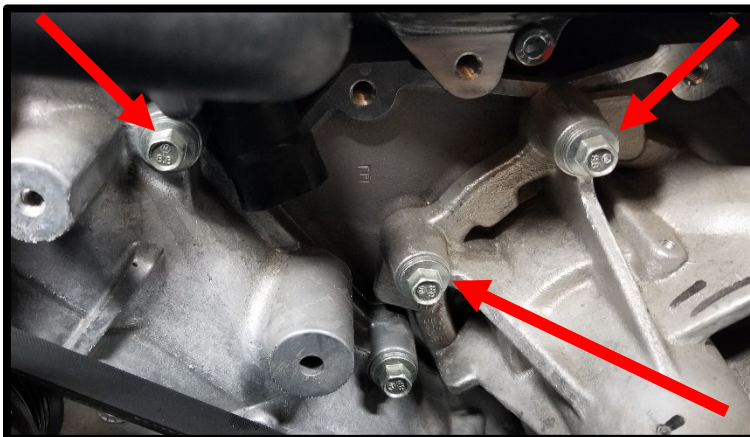

54. Using a 24mm socket, remove the fuel PSI sensor from the factory fuel rail. Install the factory fuel PSI sensor to the rail using a 24mm socket. Torque to 53 lbs-in, then an additional 25-degree rotation. **NOTE: Never use pipe sealant on the threads.**

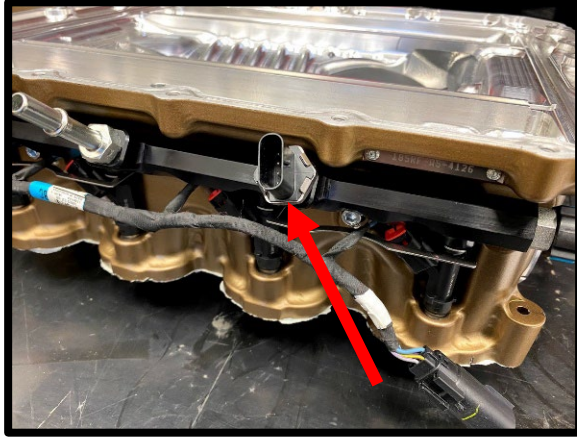
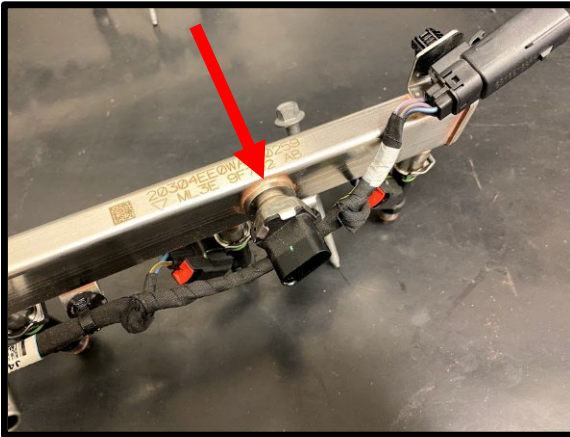

55. Install the supplied (1x) #2-906 Viton oring to the (1 of 2) 45mm long 9.49mm inlet fitting to fuel rail. Apply light amount of grease to oring for ease of installation, install to rail.

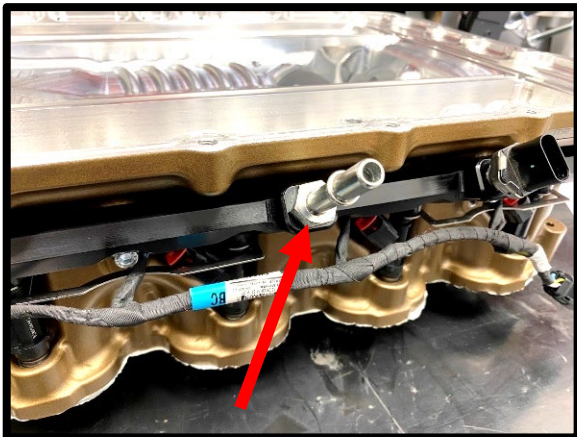

56. Install the supplied (1x) #2-906 Viton oring to the (1 of 2) 45mm long 9.49mm outlet fitting. Apply light amount of grease to oring for ease of installation, install to rail.

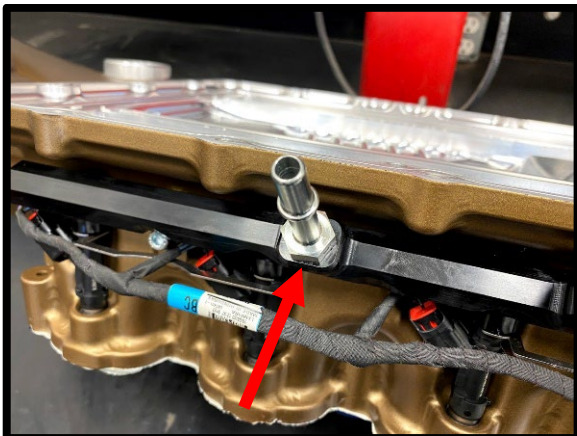

57. Install the supplied (2x) #2-906 orings to the (2x) inlet/outlet fittings. Install these (2x) fittings into rear side of fuel rails. Apply light amount of grease to oring for ease of installation. Using a $\frac{3}{4}$ " wrench (or $\frac{3}{4}$ " deep socket) on both the front and rear fittings, tighten both.



58. Install the stock injector pigtails to the fuel injectors. Install the supplied (4x) fuel injector position lock brackets to clock the supplied fuel injectors into proper position (*Stage 1 uses stock injectors, Stage 2 uses supplied injectors*). While installing the lock brackets, secure the fuel injector so it does not add pressure to the injector body. **Note:** This is for dual spray pattern injectors only that must be at the correct angle. **TIP:** *Failure to clock the injector correctly can cause severe running issues and motor failure.*

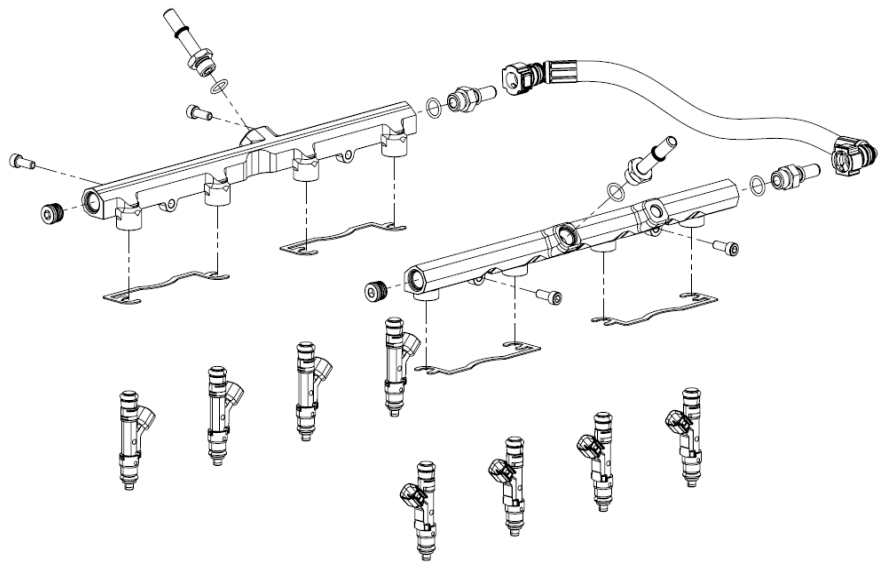
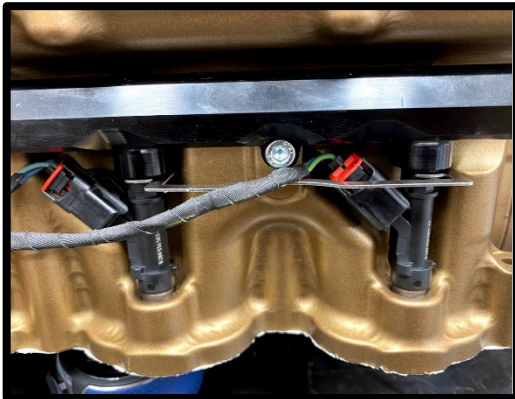

59. Apply generous amount of grease to the injector orings for ease of installation. Install the fuel injectors (*Stage 1 uses stock injectors, Stage 1R and 2 uses supplied injectors*), rails and lock bracket to the intake manifold, secure with the (4x) 6mm x 16mm SHCS using a 5mm allen socket and use **Blue Loctite #243**. Torque to 90 lbs-in.

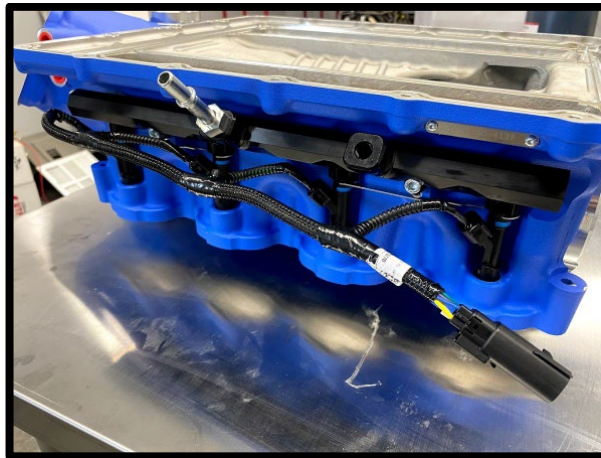

60. Install the supplied 1/4" ID bypass actuator to the bypass nipple and 1/4" 90deg nipple on SC inlet bypass hose. **CAUTION:** Do not open/close bypass actuator by hand. This may damage actuator internally. It only moves properly with equal vacuum/boost at the actuator reference port.

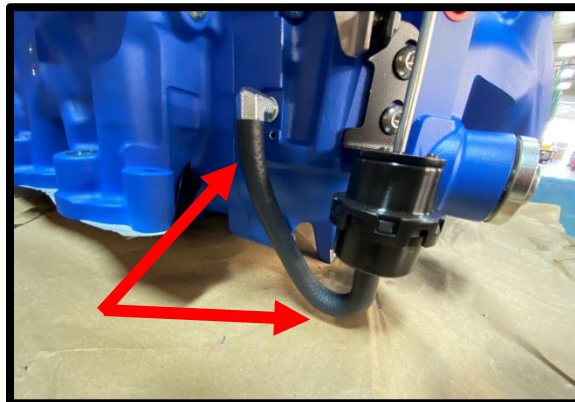

61. Install the (3x) supplied 6AN viton orings (#906) to the (1x) -6 ORB to 9.89mm, the (1x) -6 ORB to 15.82mm and (1x) -6 ORB plug supplied from bag WBG-FORD-009. Bank 1 side, install (1) 15.82mm fitting to port using a 7/8" deep socket. Bank 2 side, install the 9.89mm fitting in the top port using a 11/16" deep socket or wrench. Bank 2 side, install (1x) 6 ORB plug to the lower port using a 6mm allen socket.

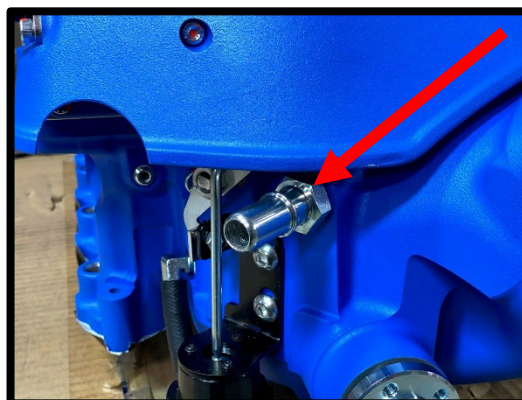
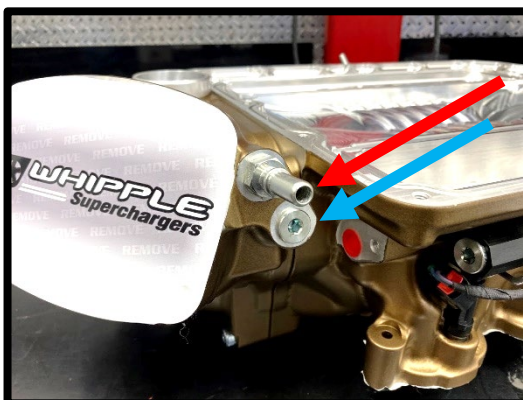

62. Using the supplied 5/16" OD silicone tube, install the (1x) 80 1/2" cord. Start as shown with green arrow, go in a clockwise motion, to the front, then around the perimeter. End at yellow arrow position. Bunch it up so it has no gap at the end as any gap will be an air leak of un-intercooled air. Install the (1x) 6.5" cord in the front section shown with the blue arrow.

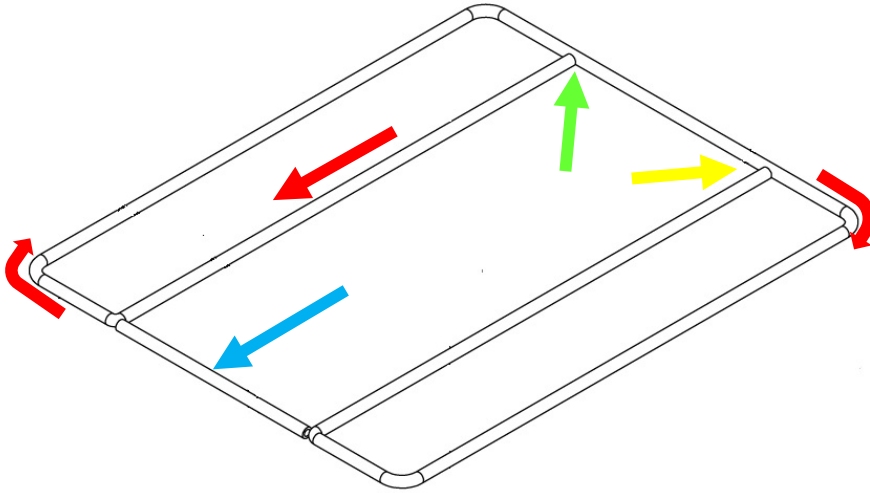

63. Install the supplied pre-formed 65.3" x .103" oring to the top sealing surface of the SC housing. Apply generous amount of grease to help ease the oring into place. **TIP:** To install oring into dove-tail groove, press vertically, vs sliding finger along.

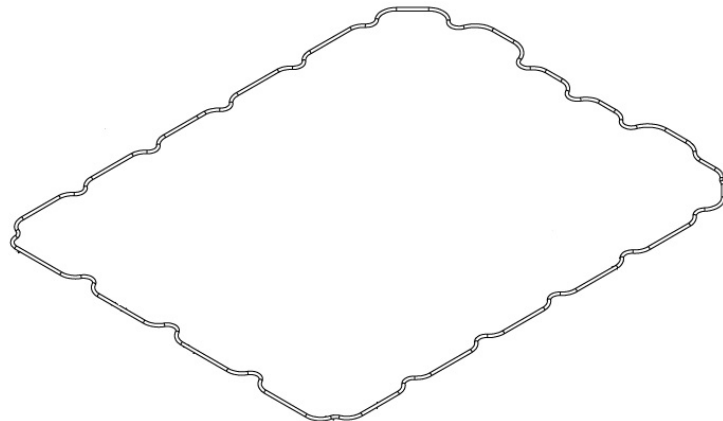

64. Install the supplied 3-bar TMAP sensor to the front of the intake manifold using the supplied (1x) 6mm x 20mm SHCS with the (1x) 6mm AN washer with light amount of **Blue Loctite #243** to the threads. Apply generous amount of grease to the rubber oring for easy installation. Torque to 65 in-lb.



65. Install the supplied TMAP pigtail to the 3-Bar TMAP supplied, wrap up to SC inlet as this will get connected to stock harness later.

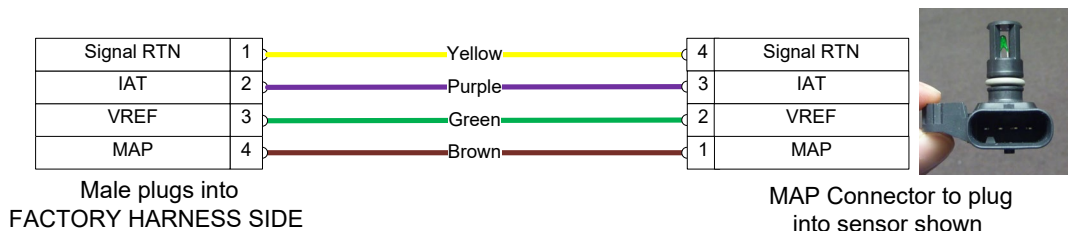

66. Install the supplied (8x) manifold orings into the Whipple intake manifold.



67. Make sure the supercharger is on a flat surface. Remove the oil fill plug using an 8mm allen socket.
- Fill the compressor to the **MIDDLE** of the fill plug (**4.0 FL/OZ**). Rock compressor back and forth. Then spin compressor/rotors by the pulley so the oil fills the bearings. **NEVER OVER FILL THE SUPERCHARGER!**
 - Apply light amount of grease to oil fill plug oring, reinstall. Torque to 140 lbs-in.

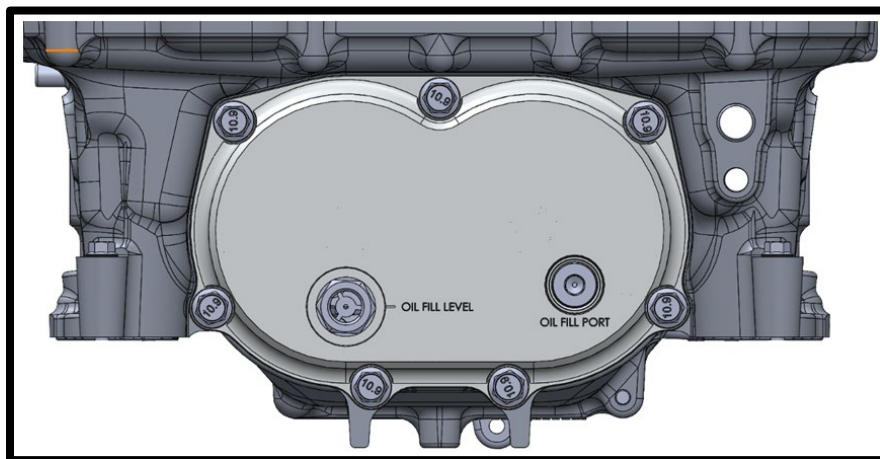

68. Remove the tape you previously installed on the exposed ports on cylinder head. Clean surface with carb cleaner or acetone.

69. Install the supercharger housing (without lid) to the engine. Use the supplied (4x) 6mm x 45mm HHFCS on the outer bolt holes as shown in image. Use the (6x) 6mm 75mm HHFCS bolts with the supplied (6x) #2-009 orings on the bolt, under the head. Use **Blue Loctite #243** on the threads of each bolt. **Leave hand tight for now.**



70. Using a 6mm allen socket, secure the (1x) 8mm x 70mm SHCS to the front support. Torque to 22 lbs-ft.

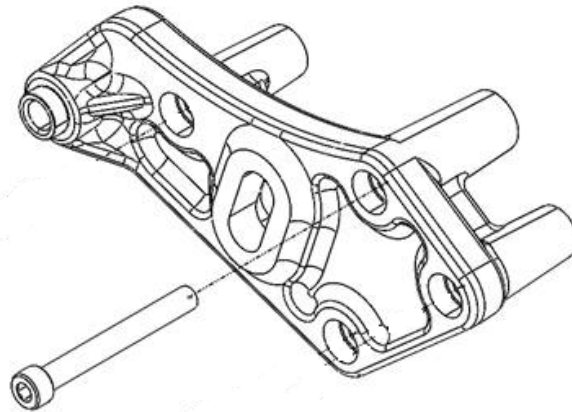

71. Torque the (10x) 6mm (10x) HHFCS manifold bolts in the following pattern using a 10mm socket. First pass: 88 lbs-in. Second pass: 106 lb-in. **NOTE:** For bolt #10, a 1/4" socket with 4"-6" extension, 10mm wobble is the best possible tool to get into this tight area.

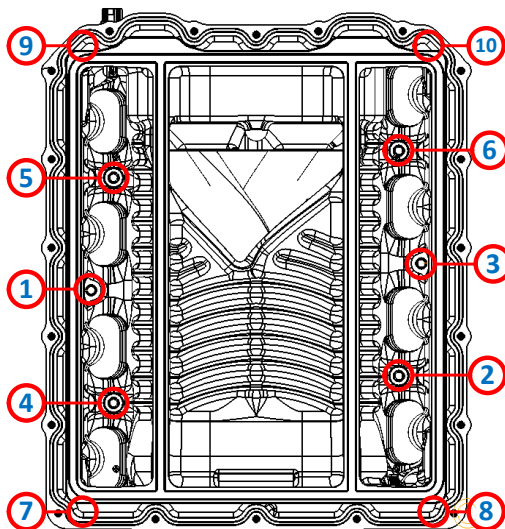

72. Install supplied 3/8" fuel cross over line around back of the supercharger by pressing until they click and lock in place. ***NOTE:** The 90deg end goes to **LH** side.



73. Connect the TMAP extension to stock TMAP 4-way connector.

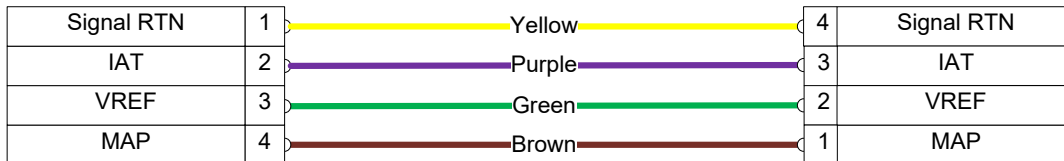

Male plugs into
FACTORY HARNESS SIDE

MAP Connector to plug
into sensor shown

74. Plug the (2x) fuel injector pigtails to the stock harness.



75. Install the supplied electronic throttle pigtail to the factory electrical connector. Route under front idler plate front

support for proper safety from belt. Push until it locks in place, then lock the safety lock. Route to **LH** side of vehicle for later connection to throttle body. **TIP:** When pressing together, hold the wires vs connector to ensure the wires do not come loose during connection.

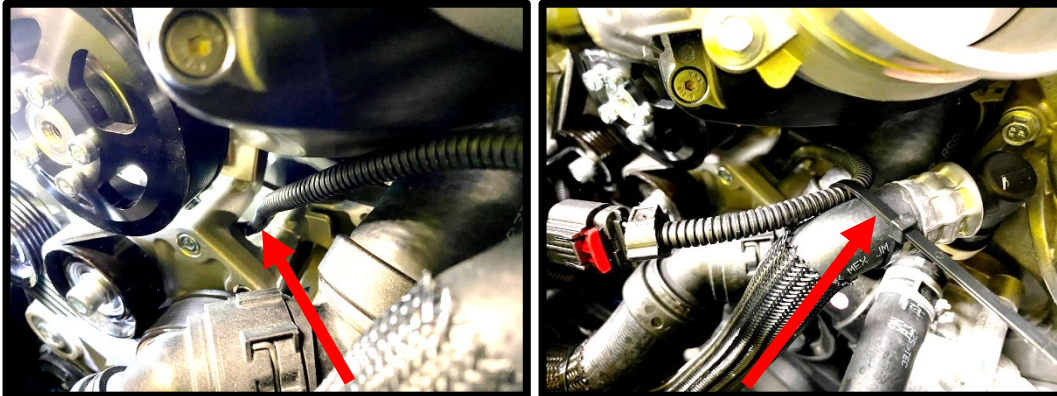

76. Reinstall the water pump pulley using a 10mm socket, torque to 14 lbs-ft.

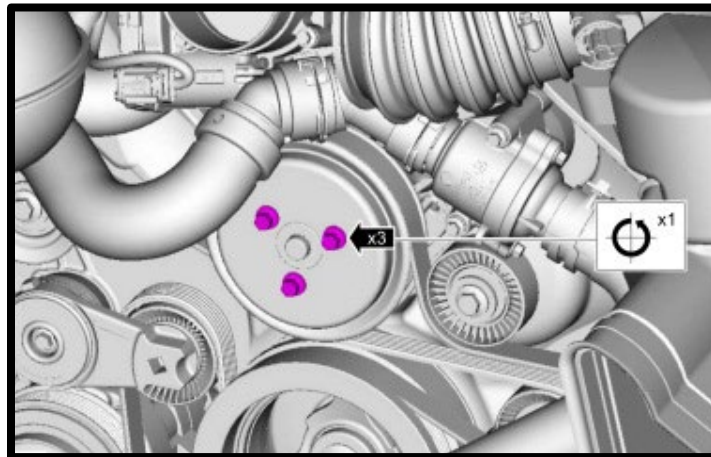

77. Install the (1x) #2-230 internal bypass oring to the lid bypass passage. Use generous amount of grease to secure oring in place and help with lid installation.

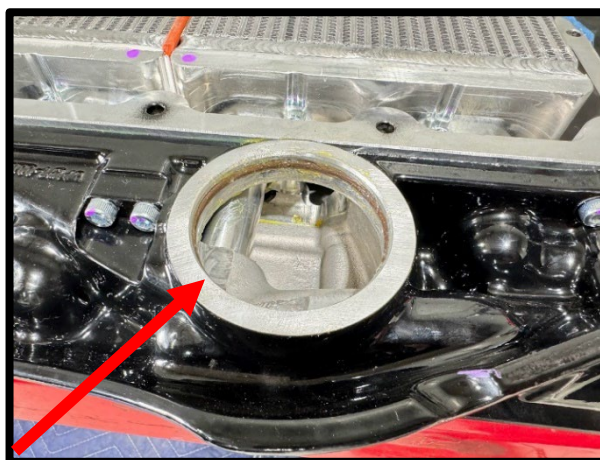

78. Apply generous amount of grease to the (1x) #2-230 Viton bypass oring. Install the supercharger lid to the

supercharger housing by carefully placing the bypass down. Secure the SC lid using the (17x) 6mm x 30mm HHFCS and (3x) 6mm x 90mm HHFCS (*marked green*) using the following pattern. Slide the EECPV bracket under bolts 3 and 5 from image (bank 2). Torque to 90 lbs-in using an 10mm socket.

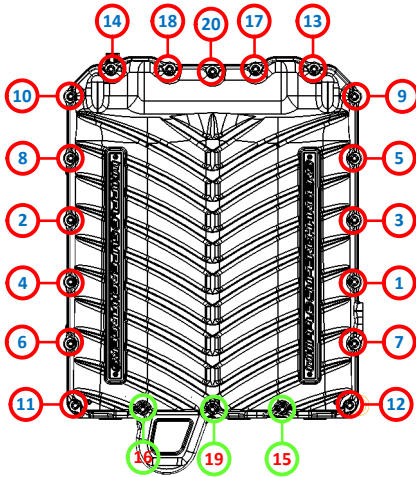

79. Connect the factory high pressure **RH** side rail fitting to the DI pump factory hose, press until it clicks and locks in place. **NOTE: THIS FUEL LINE HAS A CHECK VALVE, NEVER FLIP ORIENTATION FROM STOCK DIRECTION.**

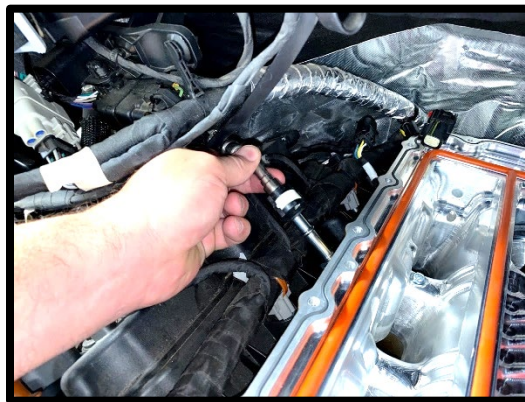

80. Connect the factory fuel inlet line to the driver side fuel fitting, press until it clicks and locks in place. Connect factory fuel psi sensor connector to sensor, press safety lock until it clicks into place.

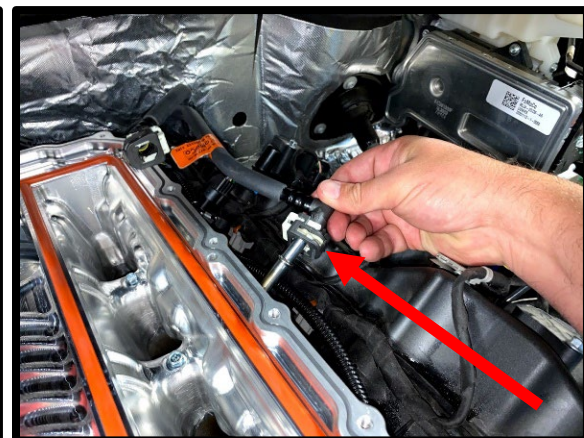
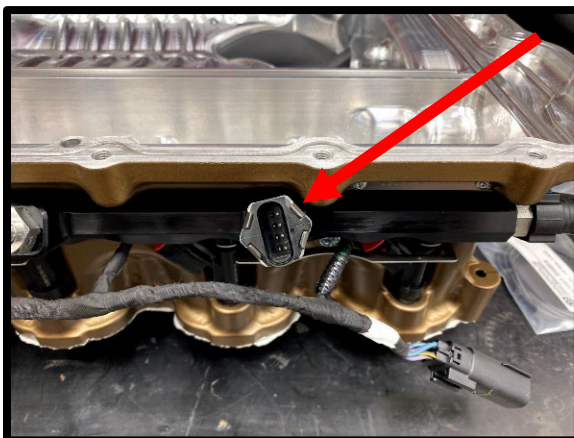

81. Slide the EECPV to the previously installed bracket. Connect factory plastic quick connect fitting to EECPV until it

clicks and locks into place. Connect 2-way electrical connector to EECPV, press locking tab back in place.



82. Install the supplied 3/8" ID x 13" with 55deg quick connect fitting hose to the EECPV barb fitting and **upper** quick connect fitting on SC inlet. Push until it clicks and locks into place.

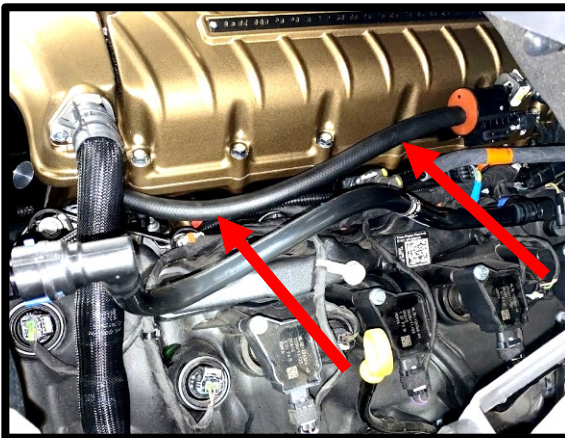

83. Install the stock PCV hose to the **RH** side valve cover. Connect other end to the supercharger inlet 15.82mm quick connect fitting. *Note: This requires you to rotate the fittings for proper fitment. Push until it clicks and locks into place.

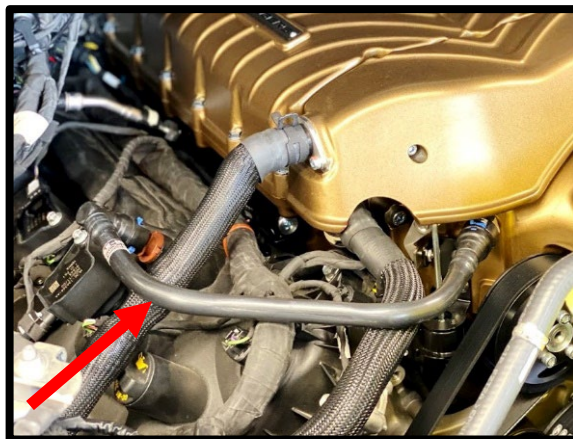

84. Connect the coolant vent line to new 5/16" 45deg barb fitting at water neck using stock clamp. Failure to do this will

result in possible leak.

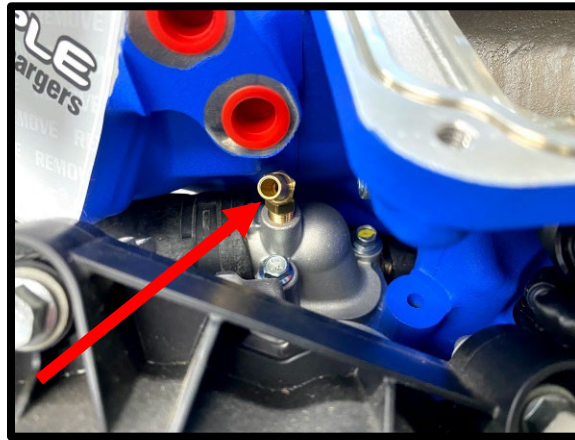

85. Install the supplied (1x) smooth idler pulley #36101 using the (1x) .390" step spacer along with the "Tee-nut" in the idler plate. The tee-nut needs to be installed from the back of the plate, this allows for belt slack adjustment. Sandwich the idler pulley to the step spacer using the supplied (1x) step spacer and (1x) ½"-13 x 1 ¾" SHCS. Leave hand tight until the belt installation.

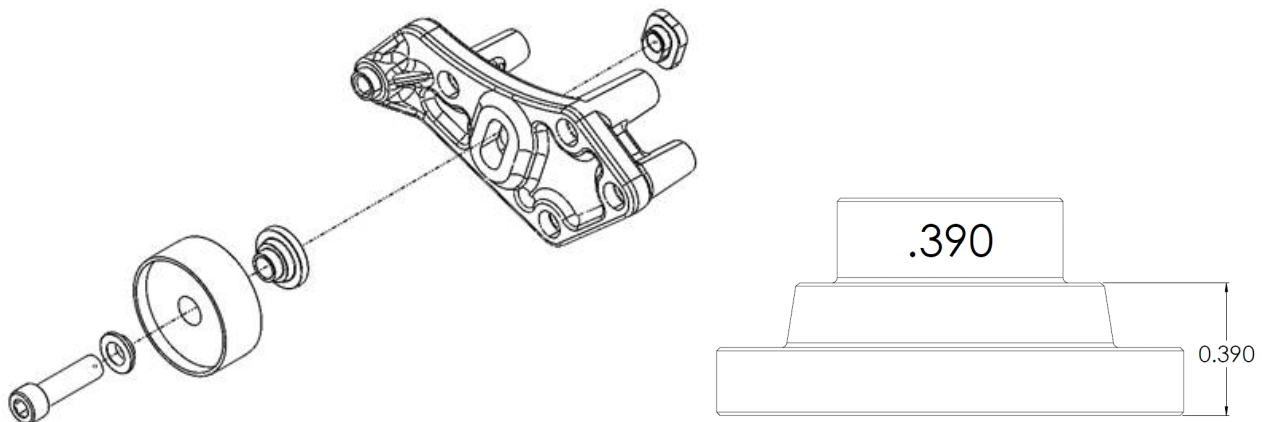

86. Install the supplied (1x) grooved idler pulley #36326 to the idler plate using the (1x) idler step washer and (1x) ½"-13 x 2" SHCS. Torque idler pulley bolt to 30 lbs-ft. using a 3/8" allen socket. Use light amount of anti-seize on threads.

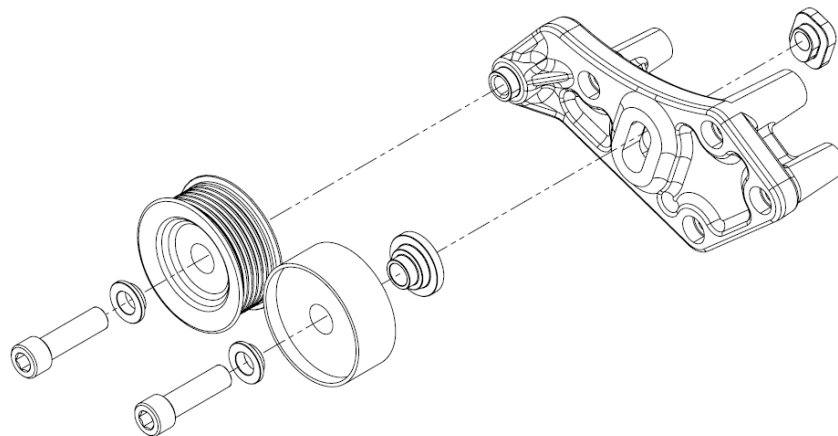

87. Install the supercharger pulley using the supplied (5x) 6mm x 15mm SHCS using a 5mm allen socket. Leave hand tight until belt installation.

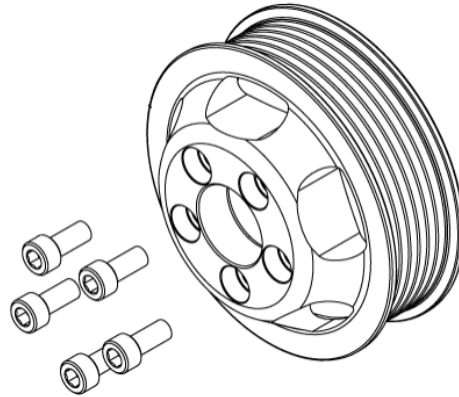

88. Install the supplied supercharger belt by following the routing diagram. Using an 15mm socket on a 1/2" breaker bar, open the factory tensioner to its max open position. Push the adjustable/sliding smooth idler pulley down as far as it can. Once in position, lock the adjustable idler pulley by torquing the SHCS to 18 lbs-ft. ***NOTE:** You must always put the tensioner at or near its max open position. Failure to set properly will result in belt issues during hard accel or decel. Changing supercharger pulley diameters may require different belt lengths.

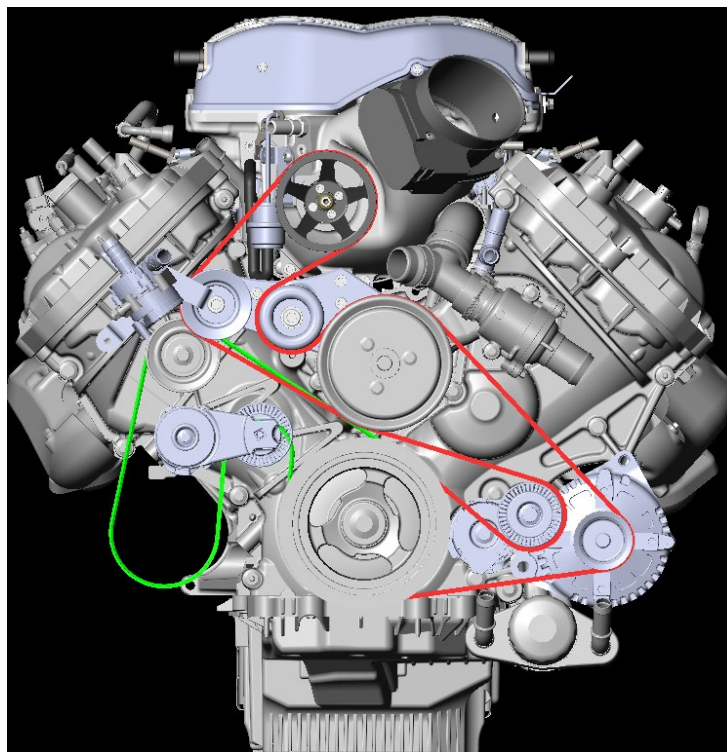

89. Torque the supercharger pulley bolts (5x) 6mm x 15mm SHCS bolts to 130 lbs-in using a 5mm allen socket.

90. Using a body panel pin tool or flat head screwdriver, remove the factory radiator closeouts from both sides of the radiator. Passenger side will not be reused, driver side will be reused.

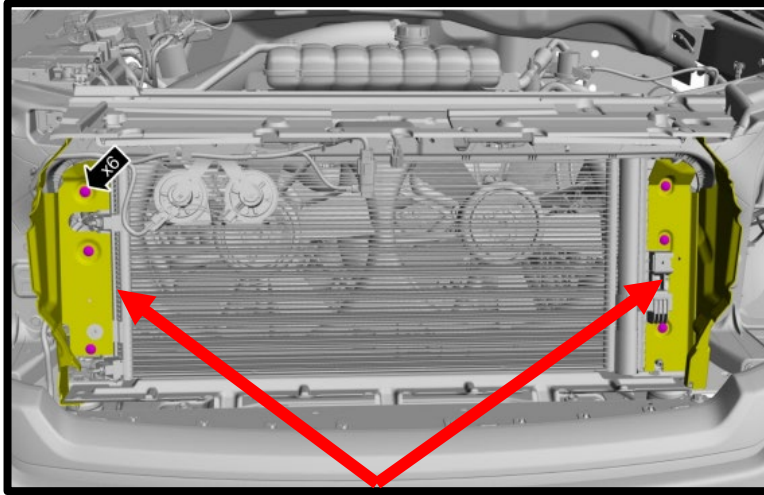

91. Remove the stock horn bracket with horns from the vehicle using a 13mm socket.

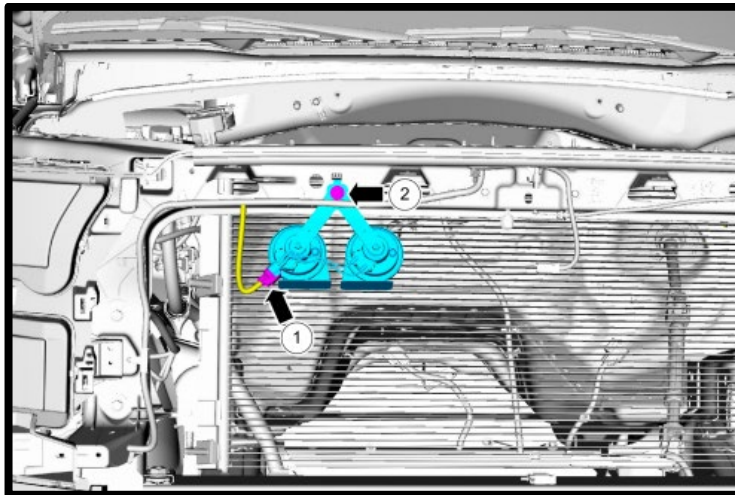

92. Install the LTR brackets to the vehicle in the factory bolt holes. Use bracket #3102655 on **RH** side, secure top bolt with supplied (1x) 6mm x 20mm hex head flanged bolts and 6mm J-clip. Install supplied (1x) 6mm x 20mm HHFCS bolt to lower bolt hole, torque both to 89 lbs-in using a 10mm socket. Use bracket #3103072 on **LH** side plastic boss, reinstall driver side radiator close out on top of #3103072 bracket leg, secure the tab to factory location. Insert the supplied dowel nut inside plastic boss as shown below, secure with supplied (1) 6mm x 16mm hex head flanged bolts, torque to 60 in-lbs using a 10mm socket and 1/4" ratchet (image shows installation of nut insert without closeout panel for example only). **NOTE: This is plastic, be cautious as you tighten.** Mount the LTR to the brackets with the barbs on **RH** side, using the supplied (4) 8mm x 16mm FHSCS and (4x) .813" sleeved washer. Torque to 18 lbs-ft. Verify the LTR cannot touch the factory radiator, it must have a minimum of .25" clearance.

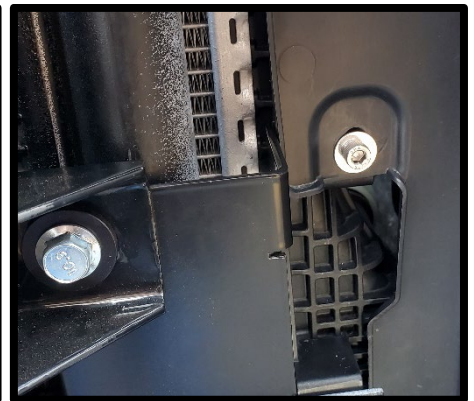
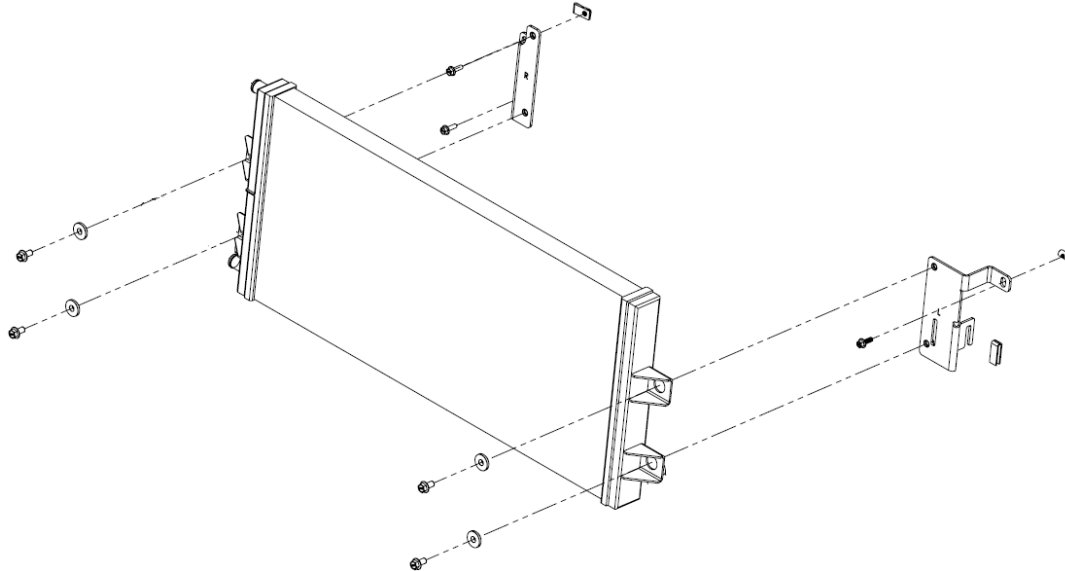

93. Remove the horns from the factory bracket and relocate them to the new supplied bracket as shown.

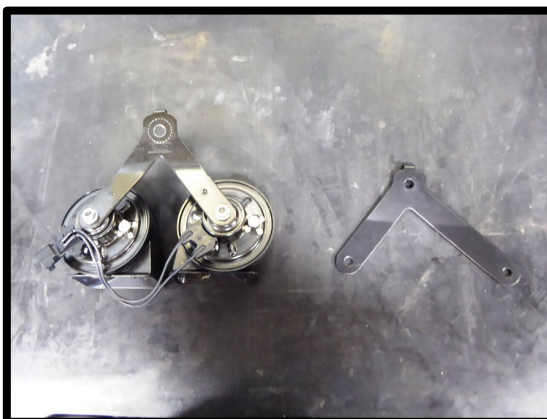

94. Reinstall new horn bracket and horns to factory location, using factory nut. Torque to 106 lbs-in. Zip-tie wire to factory harness for clean installation.

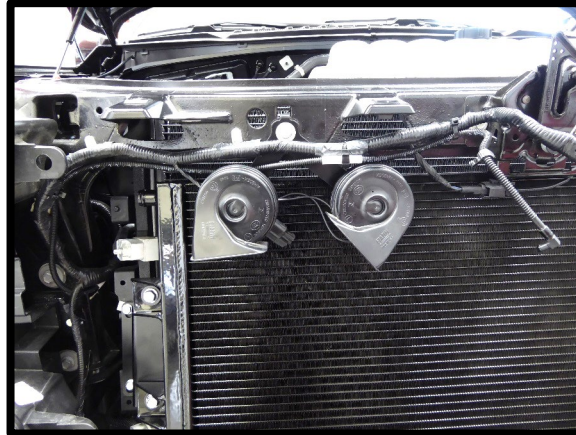

95. Using a saw or shears, cut the plastic shroud as shown, below the RH side heat exchanger fitting. This will allow proper clearance for the hose to be installed later.

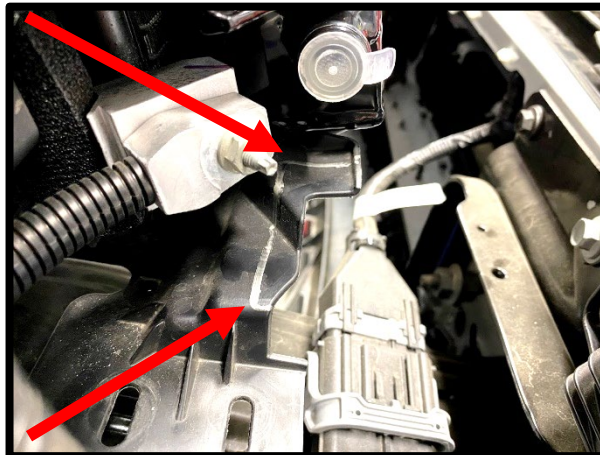

96. Install the supplied pump mount bracket (with 2x nutserts) into frame opening on **LH** side.

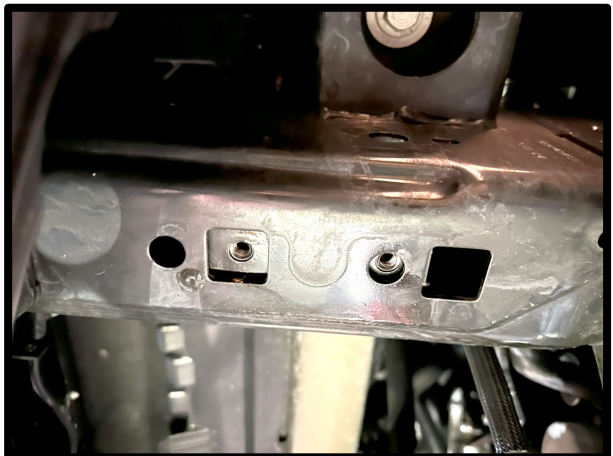
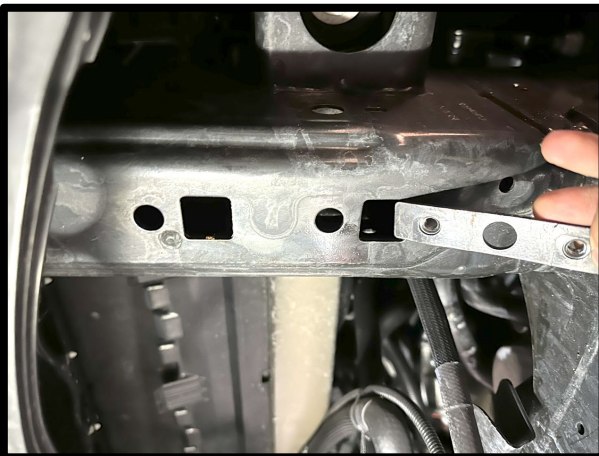

97. Mount pump to pump bracket using the supplied t-bolt clamp around the rubber section. Secure t-bolt clamp to bracket using the (2x) 6mm x 10mm HHFCS bolts. **NOTE:** Outlet fitting should be facing straight up.

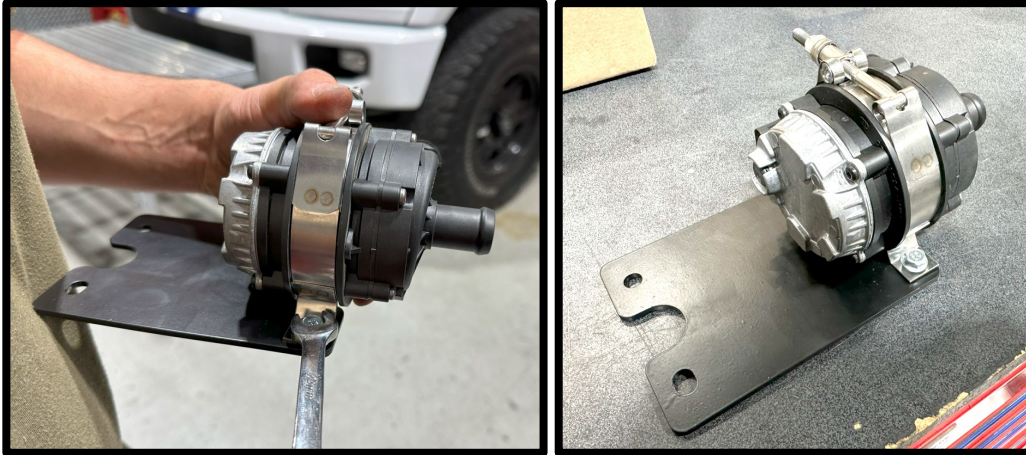

98. Mount the IC pump bracket to previously installed bracket using the (2x) 6mm x 14mm HHFCS bolts.

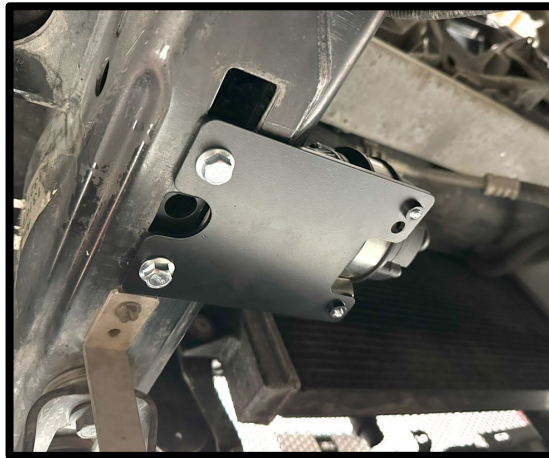

99. Using a 10mm socket, remove the stock coolant reservoir **LH** side bolt. Install the IC filler tee bracket under the coolant reservoir mounting tab. Reinstall factory bolt. Secure filler tee to the bracket using the (2) 6mm x 14mm HHFCS (10mm allen socket).

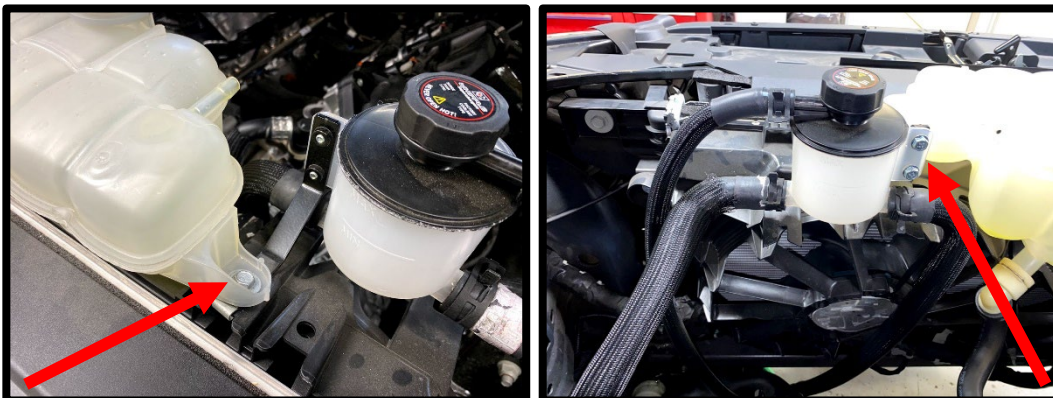

100. Install the supplied $\frac{3}{4}$ " ID x 34" molded/formed hose (#3103500) with the 90deg end on the LTR bottom **LH** side fitting. Secure both ends with supplied pinch clamps. This must clear the plastic shroud and AC stud or it will wear a hole in hose. ***NOTE:** Use zip-ties to secure hose to core support.

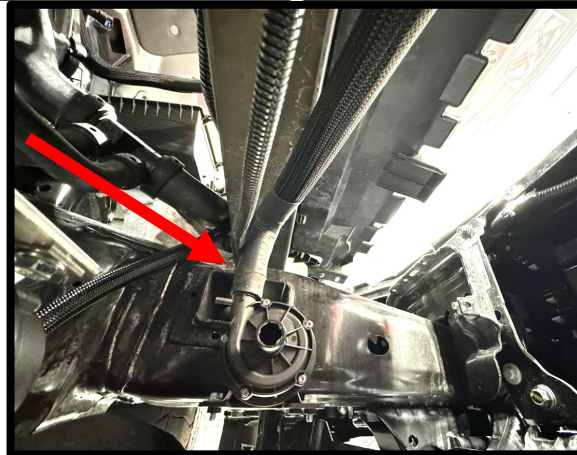
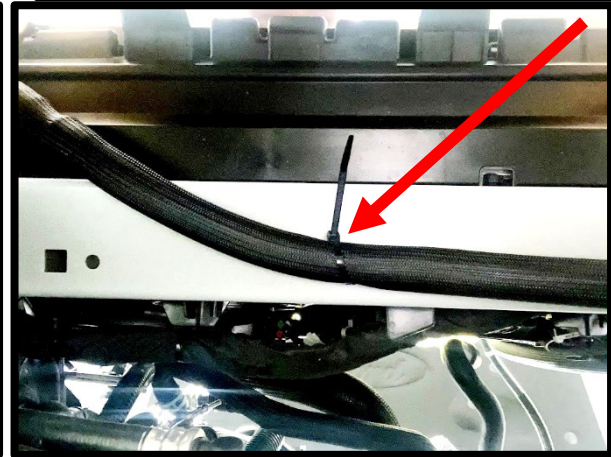
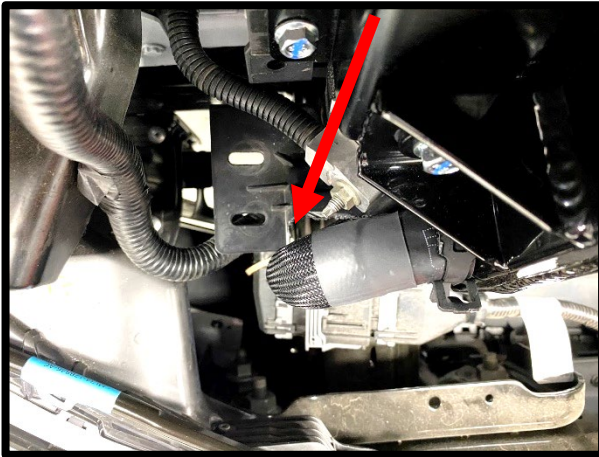
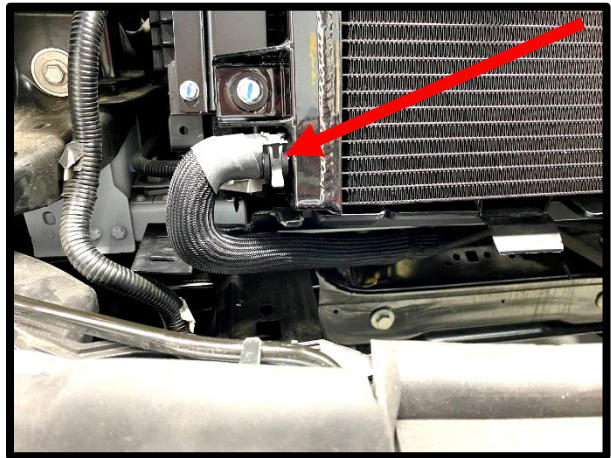
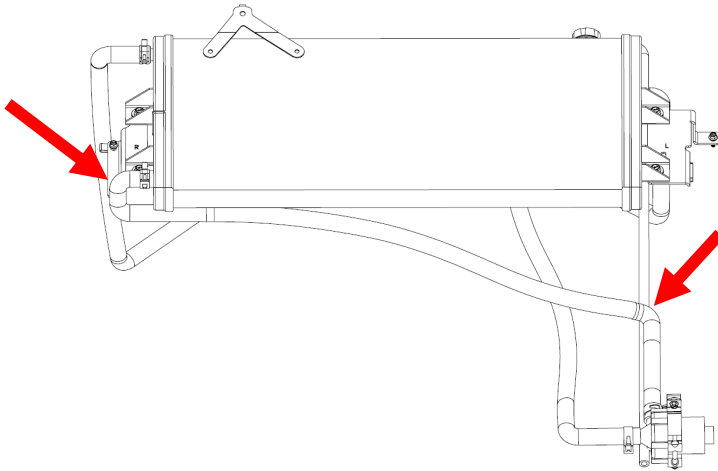

101. Install the 3/4" ID x 32" hose (#3103499) and the 3/8" ID 39" (#3103098) rubber hoses to the IC filler neck. Secure with supplied #12 worm clamp at reservoir #16 pinch clamp at pump. Connect the 3/4" hose to the IC pump inlet fitting, secure with pinch clamp. Secure 3/8" vent hose with zip tie to the 3/4" hose. **NOTE: Ensure that this hose cannot kink or rub anything overtime.**

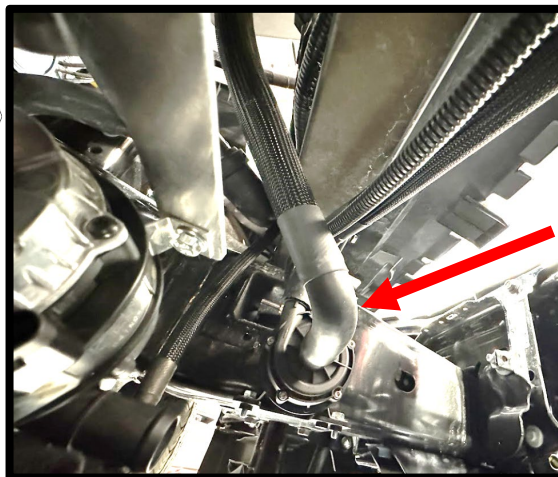
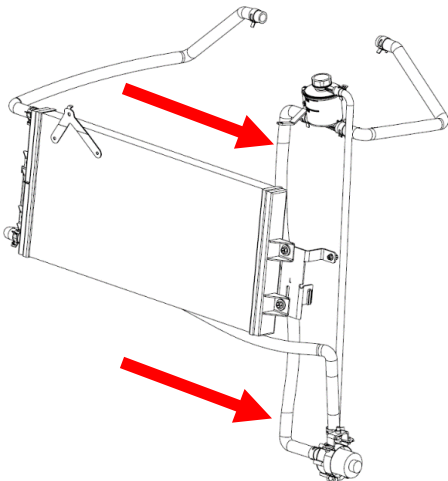

102. Install the IC reservoir 3/8" vent hose to reservoir 3/8" barb, secure with #4 worm clamp. Route down to IC pump outlet hose and secure to it using zip-tie.

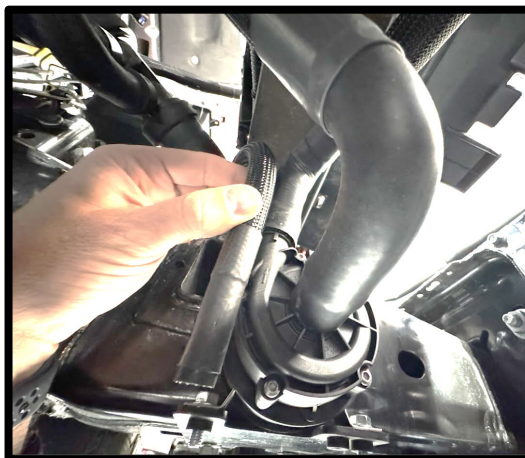

103. Install the 3/4" ID x 12" rubber hose (#3103092) from the **LH (OUTLET)** IC fitting to the IC filler neck. Secure both ends with supplied #12 worm clamps. This goes under the air inlet tube. **NOTE: NEVER SWITCH THE INTERCOOLER ROUTING, BANK 2 IS ALWAYS THE OUTLET!**

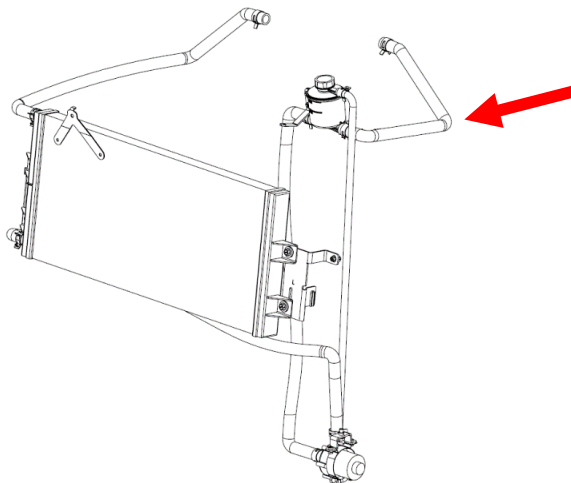

104. Install supplied $\frac{3}{4}$ " ID x 22" hose #3103093 90deg end to heat exchanger top fitting. Route other end to **RH (INLET)** intercooler fitting. Secure with supplied #12 worm clamps. ***NOTE:** Make sure the hose does not and cannot kink during routing. **DO NOT** lay the hose on the cam sensor wires, this will lead to failure over time.

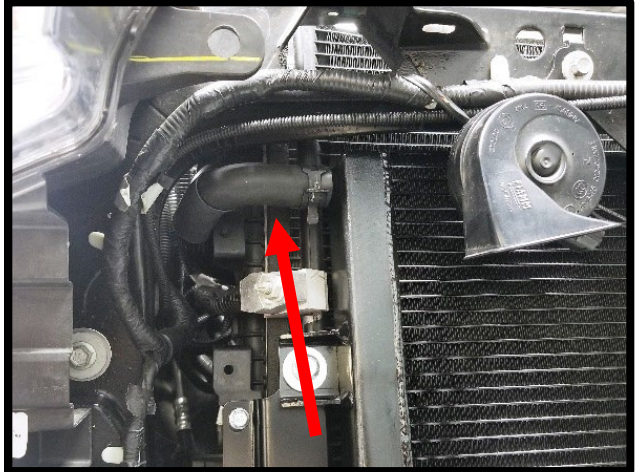
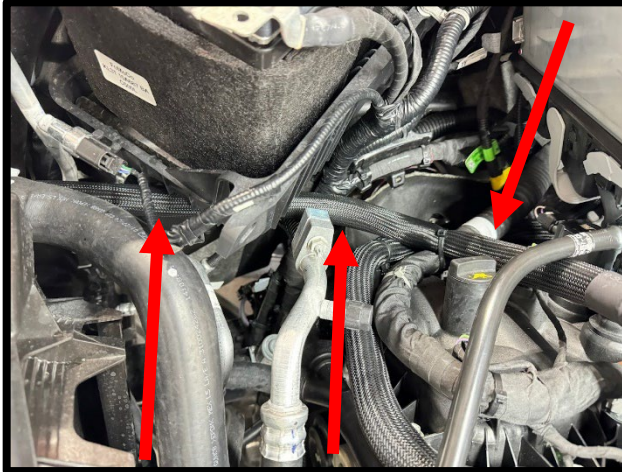
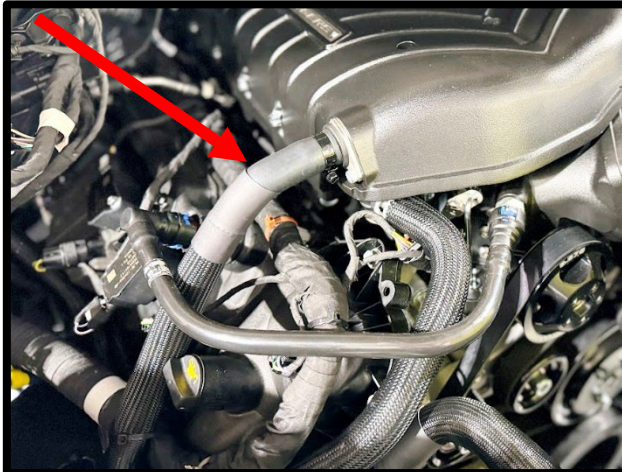

105. (**Stage 1 and Stage 1R Stock throttle body**) Install throttle body adapter to supercharger inlet using the (4) 6mm x 20mm FHCS bolts and supplied gasket between TB adapter and SC inlet. Apply **Blue Loctite #243**, torque to 65 lbs-in. Install the stock throttle body using the (4) stock bolts using a 10mm socket, torque to 80 in-lbs.

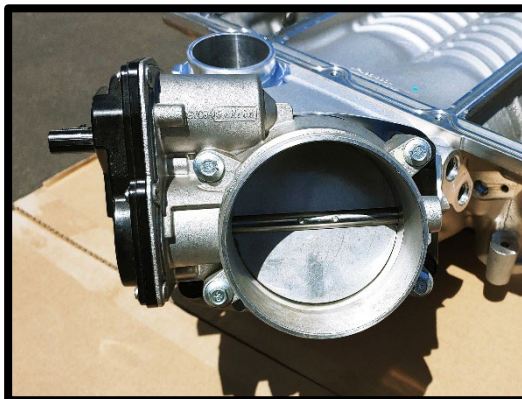

106. **(Stage 2 Whipple 132mm Crusher throttle body)** Install throttle body to supercharger inlet, use the supplied gasket between TB adapter and SC inlet. Secure with the supplied (3x) 6mm x 25mm SHCS and (1x) 6mm x 50mm SHCS using a 5mm allen socket. Torque to *89 lbs-in* on first pass, *139 lbs-in* on second pass.

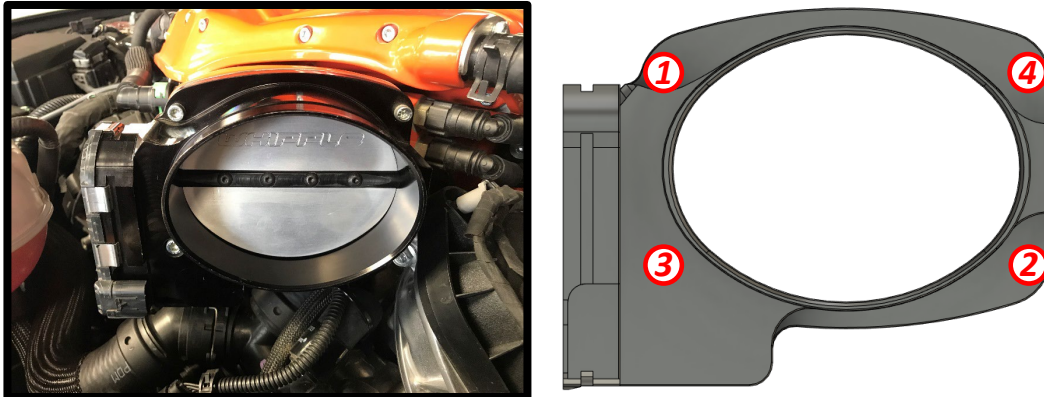

107. Connect the electronic throttle extension to the electric motor. Press until it clicks and locks into place. Press the safety lock until it clicks and locks into place. **NOTE: Secure harness with zip-tie. It should have some slack around connector for motor vibration, only zip-tie to avoid belt system.**
108. Lightly bend the (2x) ground wire so it goes below the frame. **NOTE: Failure to do so will rub airbox and push airbox towards firewall and cause fitment issues.**

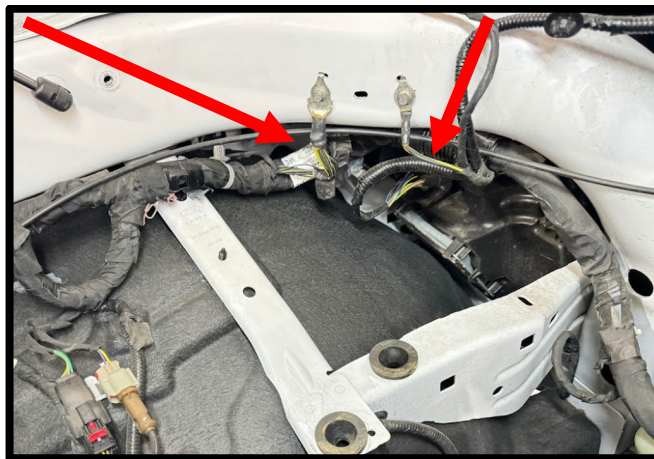

109. Remove wiring loom plastic retainer from vehicle to relax the wiring harness.



110. Cut the plastic push pin coming up from the **LH** inner fender so it only has .125" protruding.



111. Remove the plastic retainer from the wiring loom.

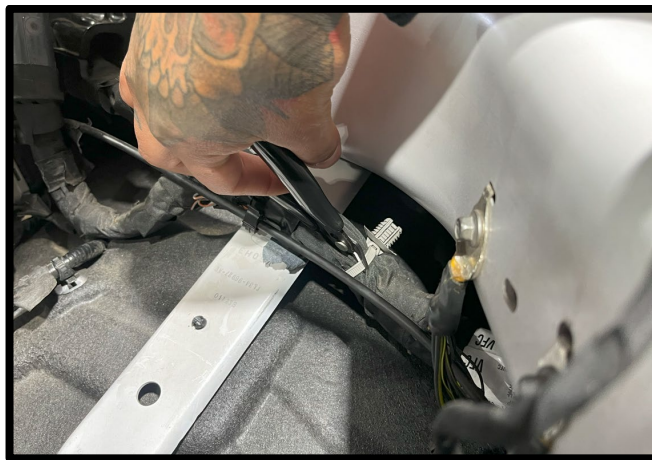

112. Add a zip tie to secure harness to frame as shown.



113. Install the supplied lower airbox into factory (2) hole locations. Using the supplied (2x) 1.1" L x .30" W plastic push pins, secure front of snorkel to factory location.

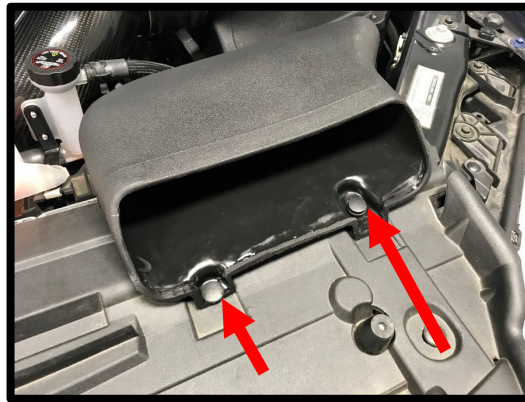

114. Install the supplied panel filter to the airbox lower. Install the upper airbox to the top of the filter. Secure the top to bottom using the supplied (6x) 6mm x 16mm BHCS. Torque to 50 in-lbs. ***Caution:** Over torquing can result in pulling an insert out of plastic box.



115. Install the (1x) supplied 13/16" to 1/2" rubber grommet into the supercharger inlet tube. Install the supplied 1/2" to 15.82mm quick connect fitting.



116. (**Whipple 132mm Crusher throttle body**) Install the supplied 5" ID x 2 1/2" silicone hose over air inlet tube and airbox lid. Install the 4 3/4" x 3" silicone hose over throttle body. Install the air inlet tube between the filter and throttle body. Slide silicone hose over throttle body. Secure all ends with the supplied (4x) #80 hose clamps.



117. (**Stock throttle body installations**) Install the supplied 5" ID x 3" silicone hose over air inlet tube and airbox lid. Install the supplied reducer silicone hose over air inlet tube and stock throttle body. Connect the other end to the stock throttle body. Secure all ends with the supplied hose clamps (2x) #80, (1x) #64 and (1x) #56 on throttle body.

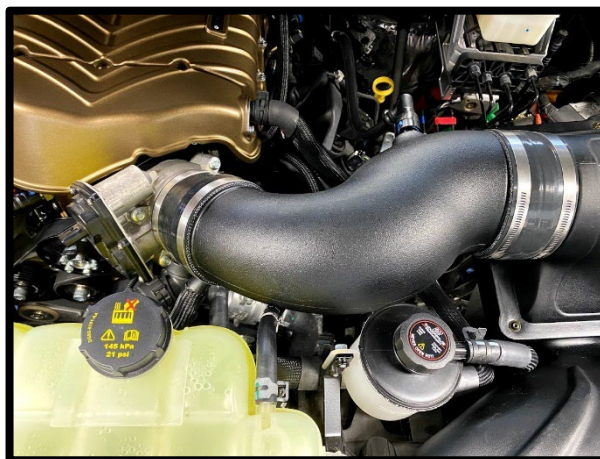

118. Install the stock make up air hose to air tube fitting previously installed. Fittings may require some rotation to properly fit.

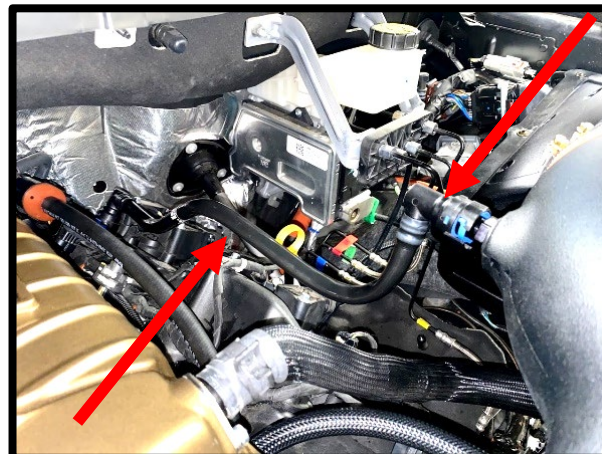

119. Locate the stock hole in the battery box as shown below. Use the supplied plastic push pin to secure the intercooler relay and fuse holder to the battery box. Route power and ground around box to fuse box area.

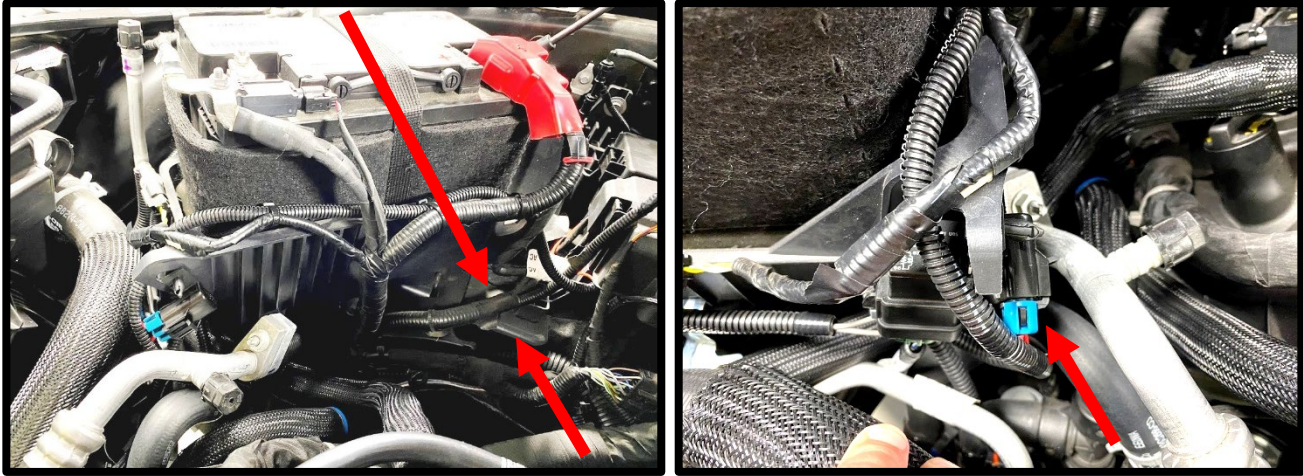

120. Using a 10mm socket, remove the nut on power stud, located on the positive stud under fuse box cover. Install the IC pump relay power eyelet (red wire) to the power stud on the battery positive (+) stud. Use a 10mm socket to secure stock and IC power wire.

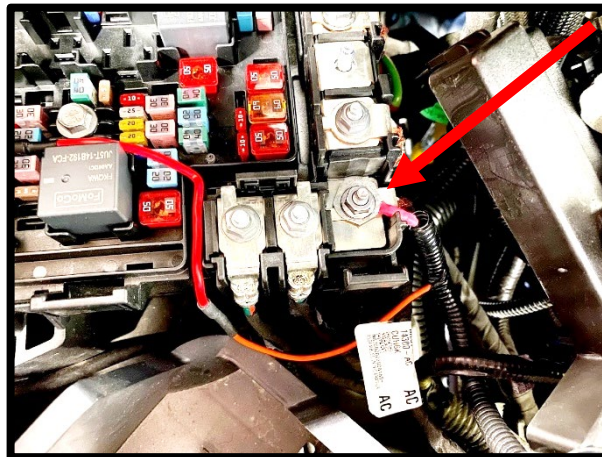

121. Remove the ground bolt from the **RH** side frame, next to the battery using an 8mm socket. Install IC pump relay ground eyelet here. Secure with factory bolt using an 8mm socket.

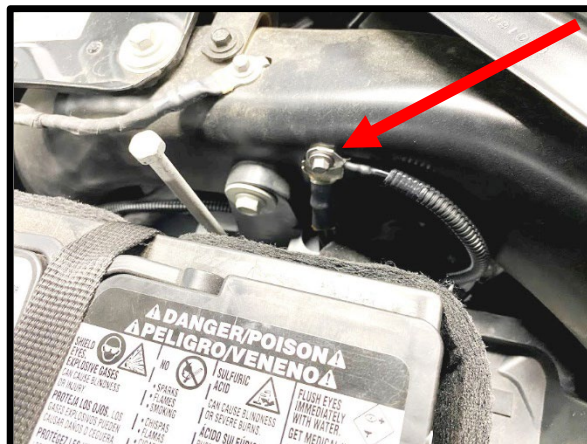

122. Pull the stock fuse from position **#F49 (ABS)**. Install the stock fuse in the empty slot on the fuse tap. Install the supplied fuse tap (with 2 fuses) into position **#F49 (ABS)**. **Note:** Stock fuse should be in bottom fuse slot, supplied 5amp should be in top fuse slot. Make small notch in fuse box lip to clear wire. Make sure wire has enough room when fuse cover closes, route around fuses for clean installation.

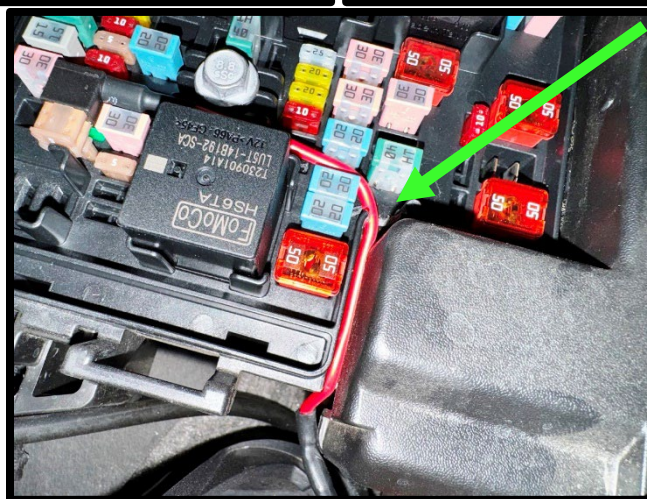
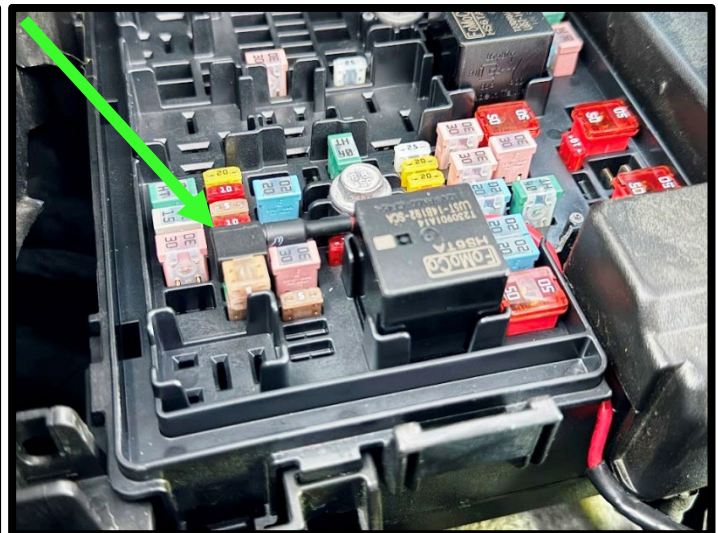
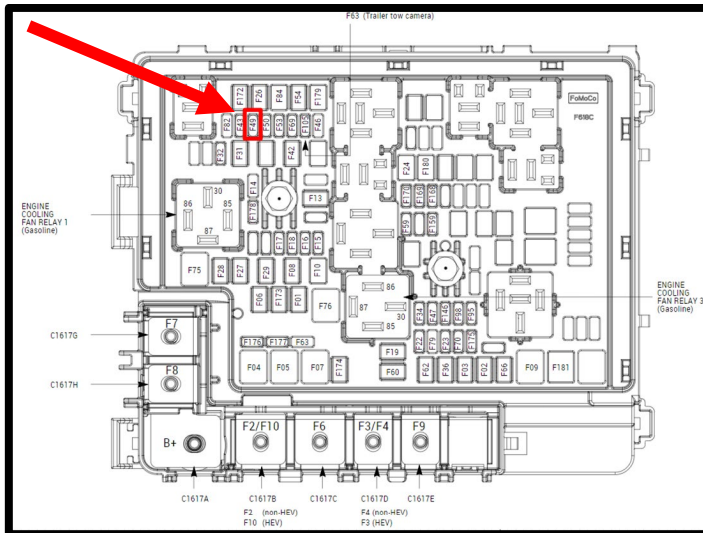

123. Test fit fuse box cover. Using small file or cutters, make small notch to lid as shown for the turn on lead.

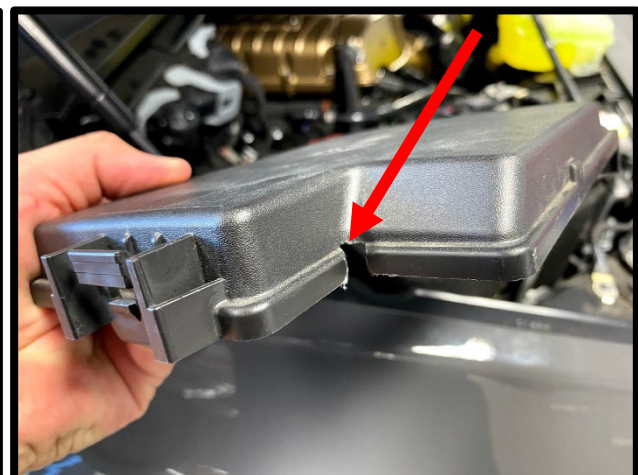
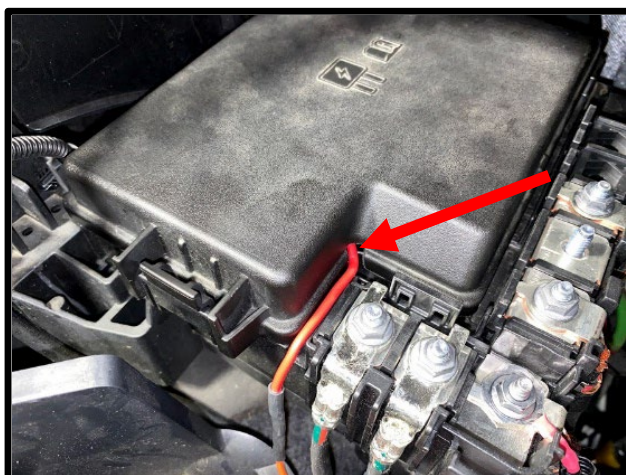

124. Secure the relay/fuse with zip-ties along with the harness for a clean installation. Route IC pump connector down below radiator, secure to IC pump previously mounted. Ensure all other wires are clear of the belt system, use zip-ties to eliminate any potential interference.



125. Refill the engine coolant. Verify that your coolant drain is closed and use a filter/strainer to pour the recycled coolant/water mixture that you drained from the radiator. If necessary, top off with a **Ford approved engine coolant**. Whipple also recommends running 2 bottles of Redline Water Wetter which can be found at most automotive parts stores. **⚠ WARNING!! NEVER USE TAP WATER OR ANY NON-FORD APPROVED ENGINE COOLANT, THIS WILL CAUSE CORROSION IN THE SYSTEM. ** (Vehicles that come equipped with Ford Motorcraft Orange must use Motorcraft Specialty Orange.**

126. Attach the negative cable to the battery and tighten using an 10mm wrench.



The electric water pump used on the Whipple SC system has a built-in micro-processor that will vary pump cycle speed when air bubbles are present in the system. If a significant amount of air is trapped in the system, the pump may cycle at a lower speed and pulsations are likely to occur resulting in poor cooling performance.

For the best result, it is highly recommended to use a Radiator Cooling System Vacuum Purge and Refill Kit to properly evacuate the air from the intercooler system before filling the 50/50 mixture of coolant and distilled water. If one is not available, the following procedure will be adequate.

WARNING: Always avoid removing the filler neck cap when the system is hot. The hot coolant is under pressure and may spray out causing burns.

127. Using a Lisle 24680 Spill-Free Funnel, or equivalent, secure the appropriate filler neck adapter to the filler neck.
128. Attach the funnel and fill with a 50/50 mixture of coolant and distilled water until the funnel is half full. Whipple recommends Ford Motorcraft or Zerex G-05 to match the stock color. Whipple also recommends 1 bottle of Red Line Water Wetter or equivalent. Note: The Whipple IC system is compatible with all common types of antifreeze. **Never use tap water, this will cause corrosion and destroy the system.** The system takes approximately 2 gallons of fluid.

129. Turn the ignition to the **ON** position, after a brief delay, the electric pump motor will cycle. Air bubbles will begin to rise to the filler tee as the coolant level drops, continue to fill while pump is running. Once its done filling to the MIN LEVEL, turn the ignition key **OFF**, the level will drop, top off with fluid. Reinstall filler cap and turn the ignition **ON** and let run for 15 seconds. Turn key **OFF**, remove cap to release air. Repeat until the filler tee holds between minimum and maximum fill level with key **OFF**. To build more pressure in the intercooler system, try squeezing the intercooler hoses while the pump is cycling. Building pressure in the system will help push the trapped air from the intercooler system to the filler tee. **NOTE:** Do not let the coolant level in the reservoir run empty as this may introduce more air into the system.



130. Cycle the ignition to the ON position again and repeat until the sound of the electric pump is continuous without any pulsation and the fluid level is met at the filler cap. **NOTE: During water pump start-up, it is normal for a slight pulsation to occur. Once the pump has reached its maximum cycle speed, no pulsations should be present. If any pulsations occur, there is air in the system. NEVER GO WOT UNTIL AIR IS BLED OUT!**
131. Several drive cycles may be required to completely purge the air from the intercooler system. During a drive cycle, the intercooler system will build up pressure as the supercharger temperature increases. Any residual air trapped in the system will have to be bled out when the cap is removed. Use a rag when removing in case there is excess pressure. **TIP: Never go WOT until air has been bled from IC system, engine failure could occur if not bled properly.**

WARNING: Triple check that the intercooler system is properly bled. Failure to do so can result in engine damage. Turn ignition on, let the pump run for 60 seconds, there should be zero cavitation during this test.

132. Reinstall the factory grill assembly in the reverse order. Reconnect the electrical connectors, including shutter motor. **Verify proper clearance to the intercooler hoses added, specifically the 180 deg heat exchanger feed hose as it will be close to the front grille. If interference is found, loosen clamp and rotate hose away from grill shell.**

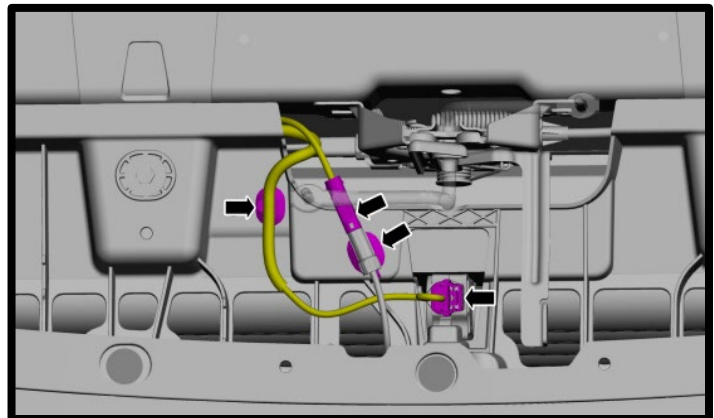
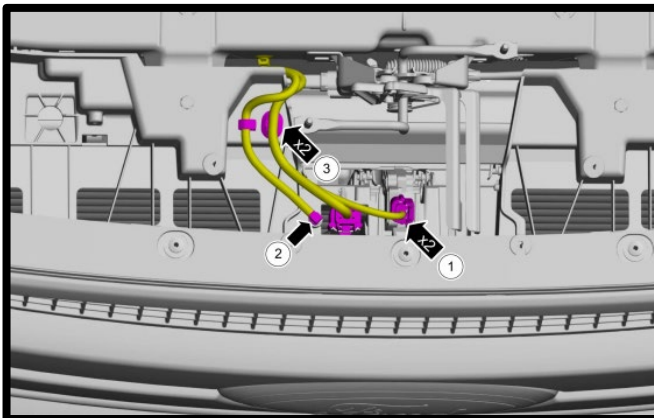

133. Install the radiator shroud cover using the factory push pins.
134. Install supplied emissions and maintenance schedule decals to underside of hood, next to factory emissions stickers or highly visible location in engine compartment. Use light amount of acetone to clean surface before installing.
135. Attach the "MINIMUM 91 OCTANE" decal to the gas tank fill cap or door.



136. Install the 5W-50 Engine oil decal to oil fill cap.



137. Turn the Ignition key on, do not start the engine (this will turn ON the fuel pump for 2 seconds). Inspect for leaks such as fuel, coolant, and intercooler coolant, correct as required.
138. Start the engine and let engine idle. The engine should idle normally between 600-800 rpm at normal operating temps. Inspect for leaks. After running for 2 minutes turn off engine and inspect the level in the engine radiator and the intercooler reservoir. With the key in the ON position engine off, inspect coolant in reservoir, the coolant should flow through the reservoir. If it does not, the coolant circuit has an air pocket trapped in it or pump power is an issue. To remove the air pocket, with key off, remove the reservoir cap and fill with coolant to mid-level. Reinstall cap, turn key on, for 15 seconds. Turn key off, remove reservoir cap and repeat until all air is bled.
139. Before driving, make sure that you have 91 or higher-octane fuel in the system. **NOT** 1/2 tank of 87 and 1/2 tank of 91, all 91 or better fuel in the system. Whipple does not recommend octane booster for low octane fuel. The system adapts to higher octane fuel when it's available.
140. Test drive vehicle for the first few miles under normal driving conditions. Listen for any noises, vibrations, engine misfire or anything that does not seem normal. The supercharger does have a slight whining noise under boost conditions, which is normal. If you chose the 132mm billet throttle body, idle may take a few minutes to learn. Using the Tomahawk tool and the data logging options, use the Whipple List and check the MCT reading while operating. This is the Manifold Charge Temperature. This is post intercooler, normal temps are 0-40deg F over ambient under normal conditions.
141. Re-check the radiator and intercooler reservoir coolant level regularly over the first 1,000 miles, top off level as needed. Do not operate at WOT until IC system is bled properly.

142. Re-check SC oil level regularly over the first 1,000 miles, level may drop very slightly as it fills the bearings and cavities.
143. Inspect belt system, readjust if necessary. It's common for the belt to stretch after first use.
144. During test driving, gradually work the vehicle to wide open throttle runs. Listen for any engine detonation (pinging). If engine detonation is present, let up on the throttle immediately. Most detonation causes are low octane gasoline still in the tank. The F150 uses factory wide band O2 sensors, which means it will control air fuel ratio to the target. Fuel trims will adapt for variances. Fuel pressure is 75psi +/- 5psi and never should dip below the specified margin. Trucks with high mileage may have clogged fuel filters or deteriorated fuel pumps. Vehicles with 50,000 or more miles should verify fuel pressure during testing. After the initial test drive, go through the belt tensioner process again.
145. If you have questions about your vehicles performance, please check with your installation facility or call Whipple Superchargers at 559.442.1261, Monday through Friday from 8am to 5:00pm, pacific time or email questions to tech@whipplesuperchargers.com.

⚠ WARNING!! Verify the bypass actuator is working properly. To monitor, look at the bypass arm when the motor is not running. Start engine and verify that the actuator arm has opened. This arm will be extended when the engine is above 1" of vacuum (boost) and will be open when there is more than 1" of engine vacuum.

There is a great deal of misinformation about the function of supercharger bypass systems. The supercharger is a positive-displacement pump; that is, so long as it is rotating, it is always pumping air. During low demand or high vacuum operation (i.e. idle, deceleration, and light throttle cruise), the pumping action is undesirable as it creates unwanted heat and noise. The bypass circuit, when open, prevents any pressure buildup across the supercharger and allows air to circulate through the rotors, allowing the supercharger to "idle" freely during these conditions. This results in reduced noise, and by reducing heat buildup in the intake, significantly improves street and strip performance. As throttle demand increases, the bypass circuit is closed, resulting in full performance and strip performance. As throttle demand increases, the bypass circuit is closed, resulting in full performance from the supercharger. The bypass circuit is never used to limit or control boost during full-throttle operation and defeating or altering the bypass function will not result in improved performance in any condition and will result in poor drivability and possible supercharger damage.

MAINTENANCE AND SERVICE

Be sure to follow the maintenance and service recommendations below to optimize the life and performance of your Whipple-supercharged vehicle.

1. Use only premium grade fuel (91-octane or higher). RON+MON/2. The PCM calibration will automatically detect higher octane levels and will increase power accordingly.
2. Always listen for any sign of spark knock or pinging. If present, discontinue use immediately and consult your vehicle owner's manual.
3. Do not operate the vehicle at large throttle opening if the MIL lamp is on steadily. This indicates an electronic engine control malfunction: reduce throttle opening to a safe location. Use the supplied flash tool to read the DTC and consult with Whipple or your Whipple dealer.
4. Check the supercharger oil level at every engine oil change. Add Whipple SC oil to the supercharger if required. Do not overfill the supercharger rear gear case.
5. Change the oil in the supercharger every 100,000 miles unless pulley is changed. Changing pulleys requires shorter mileage intervals. Use Whipple SC oil or Ford #XL-4 only.

CAUTION!! Severe damage to the compressor will occur if you overfill the supercharger rear gear case.

6. Service or replace your high-flow air filter element every 10,000 miles.
7. **Replace spark plugs every 20,000 miles. Only run specified plugs. Failure to replace plugs could lead to engine damage.**
8. Follow your factory service intervals for oil changes and other typical maintenance items.
9. Check the supercharger/accessory drive belt. Change every 25,000 miles or sooner.

CAUTION!! Any modification to your vehicle's new computer program may cause serious damage to the engine and/or drive train. The PCM is locked to the VIN, never let anyone, including dealerships install updates to the PCM. Modifications to the PCM will lock power to stock power levels.

CONGRATULATIONS

Your new Whipple Supercharger is engineered to significantly increase your engines power across a broad range of RPM's. It is Whipple's goal to improve your driving experience for many miles and years to come.

Whipple Superchargers operate as an air pump and contain internal rotors that are driven by the engine's crankshaft and serpentine belts. The supercharger compresses outside air and channels it into the engine's intake ports. Because of their design, superchargers may generate some additional noise over the standard, normally aspirated induction system.

At idle, you may hear a medium-pitch rattle from the supercharger main housing. This will diminish at about 400-500 rpm above idle.

You may also experience a muffled high-pitched whine during acceleration. This is caused by the pumping action of the supercharger compressing air and only occurs during boost conditions. It is inaudible during part-throttle acceleration. These are normal noises associated with any supercharger and have no effect on supercharger performance or engine durability.

Your supercharger is warranted by Whipple Superchargers, please see your terms and conditions on the back of your invoice for more information in regards to the limited warranty. **NOTE:** Whipple Superchargers will not authorize any warranty repair work or supercharger replacement for normal noise.

IMPORTANT INFORMATION

ENGINE BREAK-IN

Low mileage-based vehicles (under 1500 miles) should always use extreme caution using heavy throttle/acceleration and high rpm. Despite the fact that today's engine parts are manufactured to more exacting tolerances than ever before, there is still a microscopic uniqueness to any one piece of metal that comes off of an assembly line. Stock engines are built for OEM break-in and OEM thermal expansion. Increased power can result in different thermal expansion and loads on OEM parts. Abusing an engine without proper break-in can lead to engine failure. Avoid using heavy throttle/acceleration and high rpm running until 1500 miles on engine. Frequently vary your engine RPM and load for at least the first 500 miles, and avoid high-RPM usage and full-throttle operation during this time. Conversely, don't "baby" the engine constantly at very low-throttle, low-RPM conditions.

CHASSIS DYNO

Due to the 135mph speed limit, one must always run in a gear that will not limit the engine rpm below 7000rpm. Therefore, 5th gear is the preferred gear. 7th gear is 1:1 and gives the highest power results, but is not available due to drive shaft/tire safety and thus will reach a limit far before peak power is made. Never run back to back runs without a proper cool down. You must let the engine cool down for 5 minutes between runs as you won't have adequate airflow to keep the vehicle in proper temperature ranges.

BOOST LEVELS

All Whipple kits are shipped with boost levels that Whipple feels achieves maximum power while maintaining reliability with stock engines (@ sea level). Higher boost levels must run higher octane levels and are not supported. *Changing pulleys will void SC and powertrain warranties.

EXHAUST

Cat-back exhaust systems help reduce heat and minimize exhaust back pressure. They do not affect the calibration and are always a good idea for added safety and performance. Long tube headers and/or high flow are not supported by Whipple nor emissions legal. ***Cut-out type or pre-axle exhaust systems that allow exhaust to be redirected in front of rear tire or pre-axle are not supported and will greatly affect system reliability.**

FUEL OCTANE

Never run a fuel octane that is below 91octane, $(RON+MON)/2$ and never run fuel with more volume than 10% Ethanol. It is recommended, when available, to run 92-94 octane. Never mix mid-level (below 91) with 91+, this is very dangerous and can cause severe engine damage. Do not attempt to increase octane ratings with generic octane boosters, many brands can lead to premature spark plug, O2 sensor and catalytic converter life and do very little to the actual octane rating (1 point is .1 octane). The PCM constantly adapts, if it senses better fuel, it will increase power accordingly, therefore quality of fuel is extremely important.

ENGINE COOLANT

Whipple recommends running a 50/50 mix of distilled water and coolant. The engine temp should run between 195-215deg F under normal driving conditions. We also recommend 1-2 bottles of Red Line Water Wetter coolant additive. This will reduce air bubble insulation, which increases overall engine temp.

FUEL LEVEL

Never operate at WOT when the vehicle fuel levels are below a 1/8 tank. Low fuel levels could cause the fuel pump to cavitate and you'll have fuel flow spikes resulting in lean conditions and consequently detonation.