



SUPERCHARGER INSTALLATION MANUAL

2007-2013 GM TRUCK/SUV 4.8L, 5.3L, 6.0L, 6.2L



***WHIPPLE SUPERCHARGERS
3292 NORTH WEBER AVE
FRESNO, CA 93722
TEL 559.442.1261
FAX 559.442.4153***

www.whipplesuperchargers.com

***A color PDF of this manual is available, email
tech@whipplesuperchargers.com for a copy***

PREMIUM FUEL ONLY (91 OCTANE OR BETTER ALWAYS) RON+MON/2

CALIFORNIA AIR RESCOURCE BOARD EXECUTIVE ORDER# D-231-48

INTRODUCTION

Before beginning installation, please read this manual and important notes:

- Please read the installation manual and verify that all items are present. If you are missing hardware or have any questions, please contact your dealer or Whipple Superchargers.
- Premium fuel (US 91 octane) is required to prevent spark-knock/detonation under certain operating conditions. Other countries must meet US 91 octane standards, RON+MON/2. If fuel of less than 91-octane is present in the vehicle fuel tank, the tank must be completely drained and refilled with 91 or higher octane to 1/8th of a tank.
- Operating your engine without the Whipple PCM recalibration can result in engine damage or failure and will void your warranty.
- Stock airboxes are required for Whipple tuning. Aftermarket airboxes are not supported.
- Supply your stock calibration (along with gear ratio, transmission type, throttle body type and any changes to vehicle) to Whipple ahead of time so your unique PCM calibration can be built prior to the PCM being shipped or calibration emailed to minimize any down time.

COMPETITION BASED PRODUCT MAY BE USED SOLELY ON VEHICLES USED IN SANCTIONED COMPETITION WHICH MAY NEVER BE USED UPON A PUBLIC ROAD OR HIGHWAY, UNLESS PERMITTED BY SPECIFIC REGULATORY EXEMPTION (VISIT THE "EMISSIONS" PAGE AT [HTTP://WWW.SEMASEAN.COM/EMISSIONS](http://www.semasean.com/EMISSIONS) FOR STATE BY STATE DETAILS.

COMPETITION BASED PRODUCT IS LEGAL IN CALIFORNIA ONLY FOR RACING VEHICLES WHICH MAY NEVER BE USED, OR REGISTERED OR LICENSED FOR USE, UPON A HIGHWAY.

IT IS THE RESPONSIBILITY OF THE INSTALLER AND/OR USER OF THIS PRODUCT TO ENSURE THAT IT IS USED IN COMPLIANCE WITH ALL APPLICABLE LAWS AND REGULATIONS.

RECOMMENDED TOOLS AND SUPPLIES

The following items are not included in this supercharger kit and it is strongly recommended that they're used for ease of installation or maximum performance:

Extra Components

2 gallons distilled water, 2 gallons GM approved coolant, 4", 8" and 12" zip-ties. Competition kits: Fuel system, MAP sensor, calibration, spark plugs.

Tools

Torque wrench (1/4", 3/8", 1/2") Safety glasses, standard and metric wrench set, 1 1/2" hole saw, 1/4", 3/8", 1/2" assorted metric socket set, 3/8" assorted metric allen socket set, 3/8" assorted torx socket set, 8mm nut driver, screw driver set, pinch clamp tool, wire cutters and drain pan (for coolant).

Tie Straps

These will be useful for securing the wiring harness away from the installation area as directed in the instruction manual. They are inexpensive and will be very handy during installation.

Sealants

Blue Loctite™ #242 or equivalent, Red Loctite™ #271 or equivalent, Green Loctite™ #648 or equivalent. All bolts that need Loctite™ are marked with: **Loctite™ (#242 blue) threads**, **Loctite™ (#271 red) threads**, **Loctite™ (#648 green)**. Thread sealant such as pipe Teflon must be used on all pipe threads.

Chemicals and lubricants

You will need some cleaner/degreaser such as carb cleaner. Motor oil and clear automotive-type grease will be useful as a lubricant and should be readily available during installation.

Clean Shop Towels

Use these to keep the installation area clean.

Symbol Key

Throughout this installation guide you will see the following symbols used:

NOTE

Used to indicate tips and information to aid in installation, maintenance, or use of the supercharger.

!! CAUTION !!

Used to indicate precautions that must be taken to avoid damage to the supercharger and associated components.

WARNING!!

Used to indicate precautions that must be taken to avoid bodily injury as well as damage to the supercharger and associated components.

GLOSSARY OF TERMS

ABBREVIATION	DESCRIPTION
ACT	Air Charger Temperature
BHCS	Button Head Cap Screw
DTC	Diagnostic Trouble Code
ECT	Engine Coolant Temperature
EGR	Exhaust Gas Recirculation
ETC	Electronic Throttle Control
EVAP	Evaporative Emissions System
FHSCS	Flat Head Socket Cap Screw
HHFCS	Hex Head Flanged Cap Screw
IAT	Inlet Air Temperature
IC	Intercooler
ID	Internal Diameter
LB-IN	Pound-force inch
LB-FT	Pound-force foot
LTR	Low Temp Radiator
MAF	Mass Air Flow
MAP	Manifold Absolute Pressure
MY	Model Year
OBD	On Board Diagnostics
OD	Outside Diameter
PCV	Positive Crankcase Ventilation
PSI	Pound Per Square Inch
SC	Supercharger
SHCS	Socket Head Cap Screw
TPS	Throttle Pressure Sensor
TRQ	Torque

PRE-INSTALLATION CHECKLIST

Before installing your Whipple Supercharger Kit, complete the following checklist.

1. Verify Condition of Vehicle: Before the supercharger kit is installed, ensure the engine runs smoothly and that the factory malfunction indicator light (MIL) is off. Only install the supercharger kit if the engine runs smoothly *and* the MIL is off.
2. **!! CAUTION !!** This product is intended for use only on STOCK, UNMODIFIED, WELL-MAINTAINED engines. Installation on a worn-out or modified engine is not recommended without factory computer and fuel system modifications. Custom engine configurations could require custom tuning and other supporting modifications. Whipple does not offer custom calibration services.
3. Verify Fuel System: Supercharger systems should only be installed on vehicles that have new or clean fuel filters. High mileage vehicles may require a fuel pump change if fuel PSI cannot be properly maintained under high flow demand.
4. Proper Octane: Use only 91 octane fuel or higher, RON+MON/2. If fuel of less than 91-octane is present in the vehicle fuel tank, the tank must be completely drained and refilled with 91 or higher octane to 1/8th of a tank.
5. Assess Cleanliness of Installation Area: Make sure your work area and the under-hood area are free from debris. This supercharger is a high-quality, close-tolerance compressor and must not be subjected to contamination by dirt or any type of foreign material. If necessary, vacuum around engine to remove any foreign material.
6. **!! CAUTION !!** DO NOT remove the protective seal on the supercharger prior to installation. Foreign material entering the supercharger will automatically void all warranties.
7. Identify Supercharger Kit Components: Before beginning installation, identify all the components of your Whipple Supercharger Kit and ensure all items are present and undamaged.
8. **!! CAUTION !!** Do not attempt to start the engine before adding the supplied Supercharger Oil to the supercharger!

SAFETY PRECAUTIONS



CAREFULLY READ THE IMPORTANT SAFETY PRECAUTIONS AND WARNINGS BEFORE PROCEEDING WITH THE INSTALLATION!

Appropriate disassembly, assembly methods and procedures are essential to ensure the personal safety of the individual performing the kit installation. Improper installation due to the failure to correctly follow these instructions could cause personally injury or death. Read each step of the installation manual carefully before starting the installation.

- Always wear safety glasses for eye protection.
- Place the ignition switch in the off position.
- Always apply the parking brake when working on vehicle.
- Block the front and rear tire surfaces to prevent unexpected vehicle movement.
- Operate the engine only in well-ventilated areas to avoid exposure to carbon monoxide.
- Do not smoke or use flammable items near or around fuel system.
- Use chemicals and cleaners only in well-ventilated areas.
- Batteries can produce explosive hydrogen gas which can cause personal injury. Do not allow flames, sparks or flammable sources to come near the battery.
- Keep hands and any other objects away from the radiator fan blades.
- Keep yourself and your clothing away from moving parts when the engine is running.
- Do not wear loose clothing or jewelry that can be caught in rotating or moving parts.



****NOTICE:** Installation of Whipple Supercharger products signifies that you have read this document and have agreed to the terms stated within.

It's the purchaser's responsibility to follow all installation instruction guidelines and safety procedures supplied with the product as it's received by the purchaser to determine the compatibility of the product with the vehicle or the device the purchaser intends to install the product on.

Whipple Superchargers assumes no responsibility for damages occurring from accident, misuse, abuse, improper installation, improper operation, lack of reasonable care or all previously stated reasons resulting from incompatibility with other manufacturer's products.

There are no warranties expressed or implied for engine failure or damage to the vehicle in any way, loss of use or inconvenience or labor reimbursement. This includes merchantability and fitness.

The information contained in this publication was accurate and in effect at the time the publication was approved for printing and is subject to change without notice or liability. Whipple Superchargers reserves the right to revise the information presented herein or to discontinue the production of parts described at any time.

SUPERCHARGER INSTALLATION INSTRUCTIONS

It is strongly recommended that you read through this guide **before** you begin installing the Whipple Supercharger.

1. (Complete kits) Using the supplied flash tool, connect to the factory OBDII connector.
 - Your computer must have a stock unaltered file or programmer will not load. If you have a modified PCM, return it back to stock to avoid any corruption issues. If your car has been tuned you will need to return it to stock before proceeding.
 - If you're unable to return it to stock you will need to take it to a GM dealer and have them update the computer.
 - Use the flash tool instructions to continue reading stock PCM. Using the flash tool, read the stock file and supply to Whipple. This is highly recommended to do before the install begins to minimize any down time. Cals may take 24-48 hours.
2. Using an air hose, blow off any loose dirt or debris from engine compartment. If really dirty, then steam clean the engine compartment before proceeding to the next step.
3. Locate the battery. With an 8mm wrench disconnect the (-) negative battery cable. Make sure the cable is far enough away from the battery that it does not accidentally touch the battery and make connection during the installation.
4. To relieve fuel pressure in the tank, remove the fuel cap.
5. With a cool engine remove the radiator cap. (Be careful not to remove the cap if the engine is still hot.)
6. Place a drain pan under the front of the truck and disconnect the heater hose on the passenger-side on the water pump. The radiator does not have a drain plug.
7. Remove the plastic engine cover by lifting up at the front and pulling the cover forward. This cover will not be re-used.

- Using an 8mm nut driver or a flat blade screwdriver, loosen the two clamps, one at the throttle body and one at the MAF sensor.



- Disconnect the loom clamp from the upper radiator hose using a small flat blade screwdriver.



- Remove the valve cover vent hose from the passenger-side valve cover. Lift and remove air intake assembly away from engine.

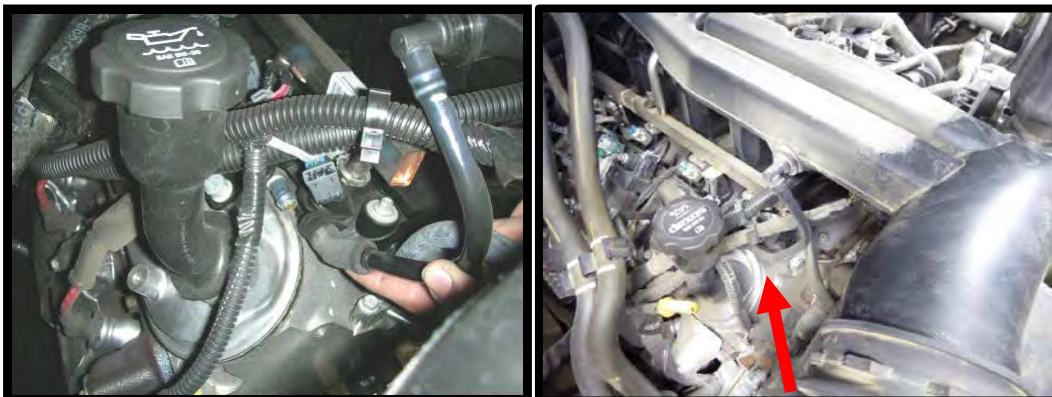

11. Disconnect the electrical connector on the top of the alternator using a 10mm socket wrench, remove the nut holding the positive (+) wire to the back of the alternator. Route the wire over towards the passenger-side fender, out of the way

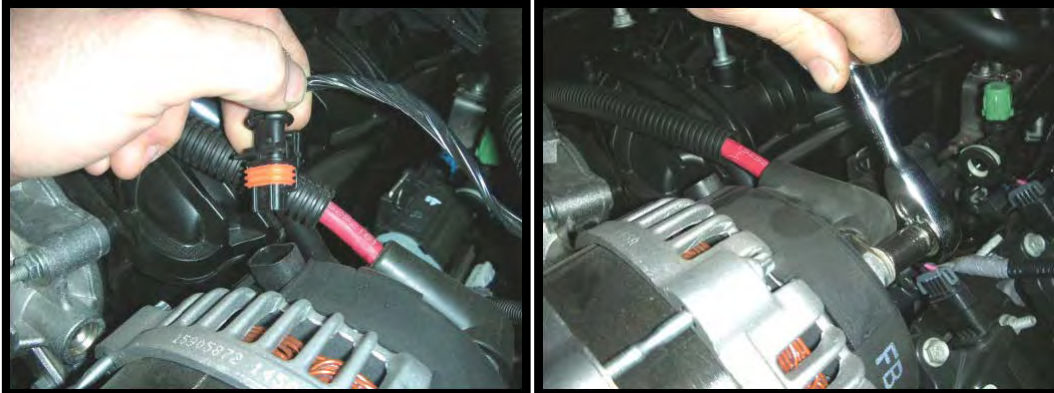

12. Remove the stock belt using a 15mm belt tensioner wrench on the tensioner pulley. With a 15mm socket wrench, remove the three bolts that hold the tensioner to the water pump and remove the tensioner.

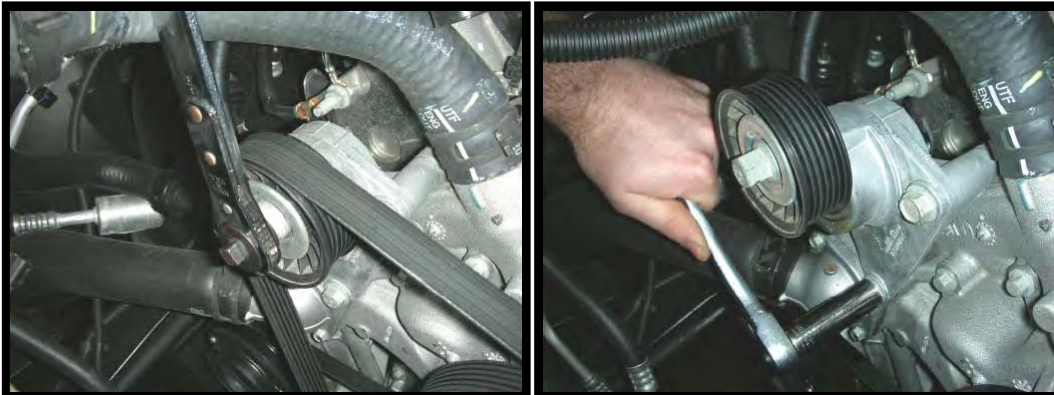

13. Using a 15mm socket wrench, remove the two bolts securing the alternator to the bracket and remove the alternator from the vehicle. Using the same socket, remove the factory smooth idler from alternator bracket.

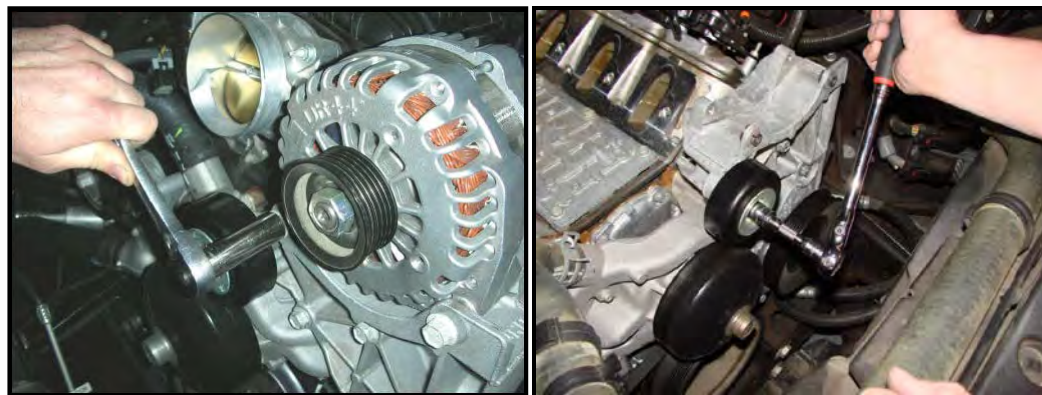

14. Unplug the electrical connector from the MAF sensor. **NOTE:** MY2009 and up vehicles, this sensor is located on the top surface, not the front surface shown in this picture, and the connection points toward the rear of the vehicle.

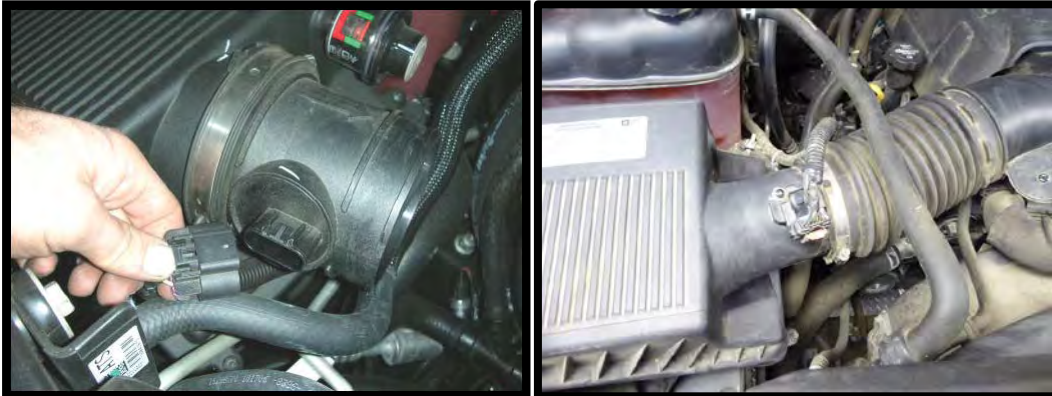

15. Using a flat head screw driver, pry open main loom support.
16. Using a 10mm socket wrench, remove the three bolts that secure engine cover support bracket to the intake manifold. Remove the wiring harness bracket from the intake manifold by removing the nut with a 10mm socket wrench. Pull wiring to the driver side to move out of the way.

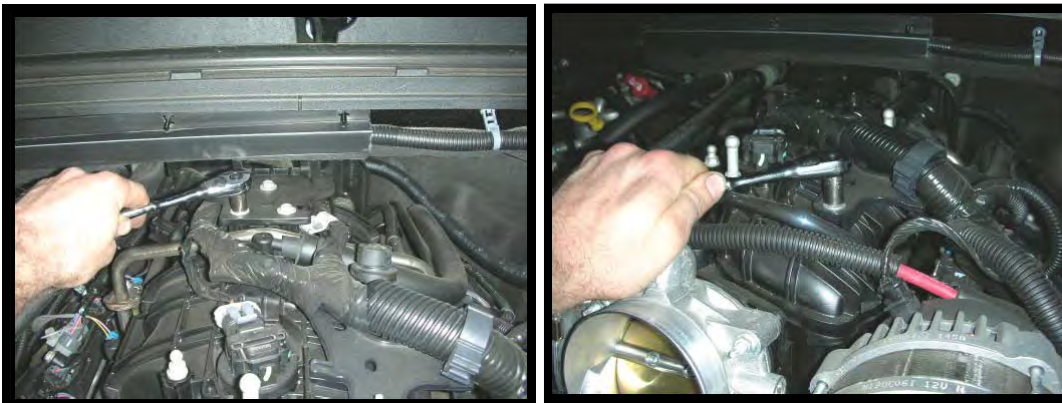

17. Using a razor blade, carefully cut through the electric tape and cable tie holding the main wiring harness loom to the bracket. Pull bracket away, this will not be used.
18. Unplug the ETC connector from the throttle body and MAP sensor.

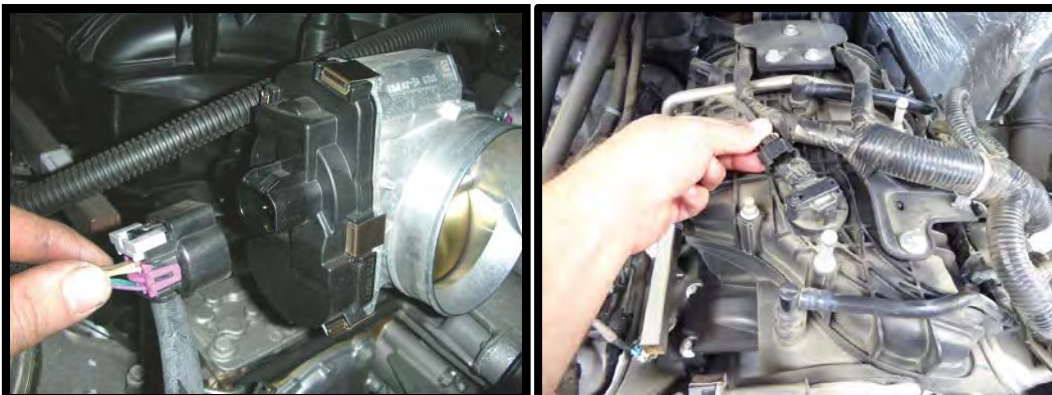

19. Disconnect the (8) fuel injector plugs by pulling up on the gray tab and then pushing in on the release tab.

20. Disconnect PCV hose from driver side rear connector located on valve cover.

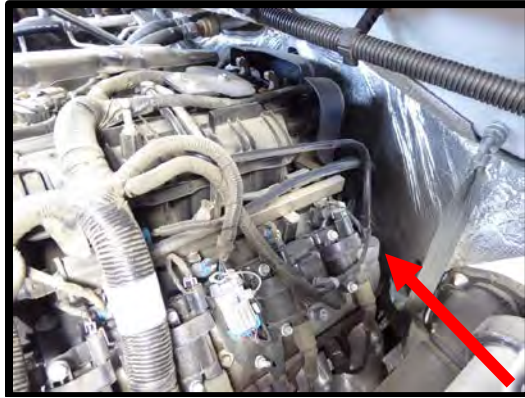

21. Unplug the EVAP electrical connector from the solenoid. Remove the EVAP lines from the solenoid by pressing in the gray retainer clip and pulling the line off of the solenoid.



22. Remove the power brake hose and check valve from the booster. This hose will not be reused, but keep the check valve as you will be using it in a later step. **Note:** If vehicle is equipped with hydra-boost then the vehicle will not have this hose.



23. **SAFETY GLASSES REQUIRED.** Remove the stainless-steel safety clip from the fuel line. Do not discard, this will be reinstalled later. Using the fuel disconnect tool provided, remove the fuel line from the fuel rail. **CAUTION! Fuel system may be under pressure. Avoid open flames or any source of ignition.**

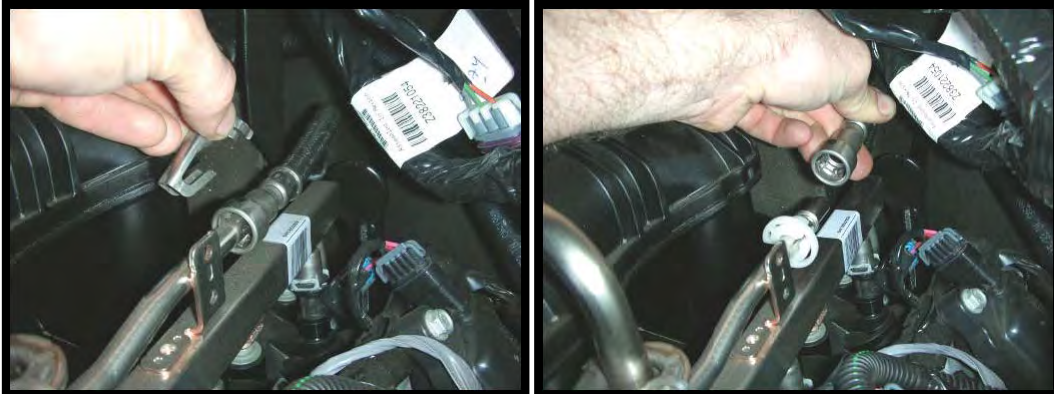

24. The intake manifold is now ready to be removed. Using an 8mm socket wrench, remove the (10) bolts that secure the manifold to the engine. Lift manifold assembly away from engine.



25. Using a vacuum cleaner remove any dirt or debris from the intake port area. **CAUTION!** Be careful not to get dirt down the intake ports.



26. Cover the intake ports with tape.

27. Remove the passenger side oil fill cap assembly. Replace with supplied flush cap, snap into lock position.

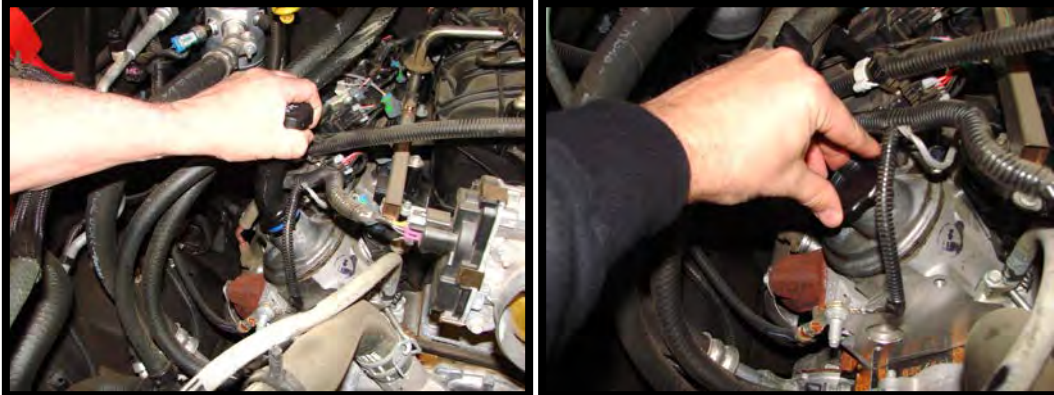

28. (MY2007+) Using a 1 1/16" open ended wrench, remove the oil psi sensor from the back of the engine. Install supplied copper washer to sensor. Reinstall and rotate sensor so the connector faces the rear of the engine. Test fit Whipple intake manifold for proper clearance.

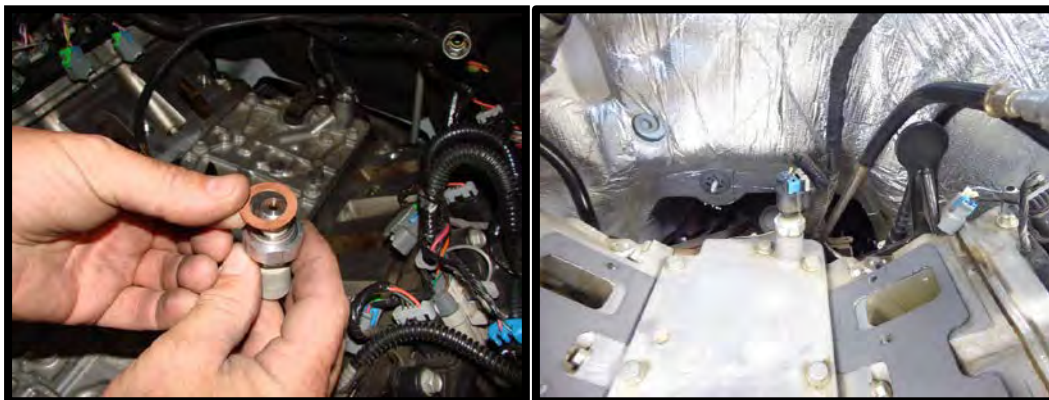

29. Using a 15mm socket, remove the factory rear bracket from engine.



30. (MY2003-2007) Remove the stock MAP sensor by removing the retaining clip with a screwdriver and then gently pulling up the sensor. Be careful not to damage the O-ring seal.



31. (MY2003-MY2007) Install supplied bushing in MAP sensor port. Use green Loctite on OD of bushing to help secure. Install the stock MAP sensor, secure using the supplied hold down bracket and (1) 10/32" x 1 1/8" SHCS bolt. Apply light amount of blue loctite to threads.

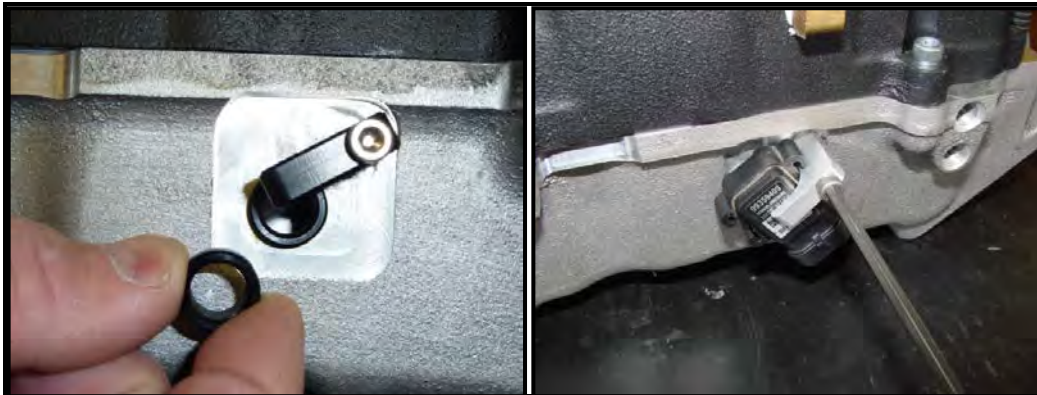

32. (MY2008+) Install supplied 3-Bar MAP sensor (PN# 12592525) too back of manifold using the supplied (1) 10-32 x 7/8" SHCS bolt, apply light amount of blue Loctite to threads. **NOTE:** Competition based kits are not supplied with MAP sensors, contact your tuner for proper sensor recommendation.



33. Install the supplied air temp sensor into Whipple manifold using the supplied rubber grommet.

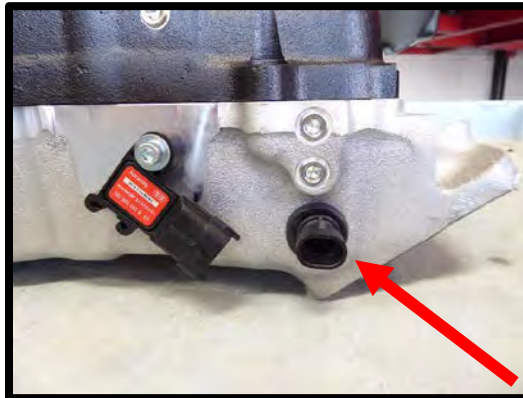

34. Connect the supplied MAP pigtail to the MAP sensor. Install the supplied MAP extension harness to the MAP sensor before install manifold. Press until it clicks in place. **NOTE: This extension could fit backwards, ensure that the color wires and pin locations match! (Pin 1 = Gray, Pin 2=Black, Pin 3=Green).**

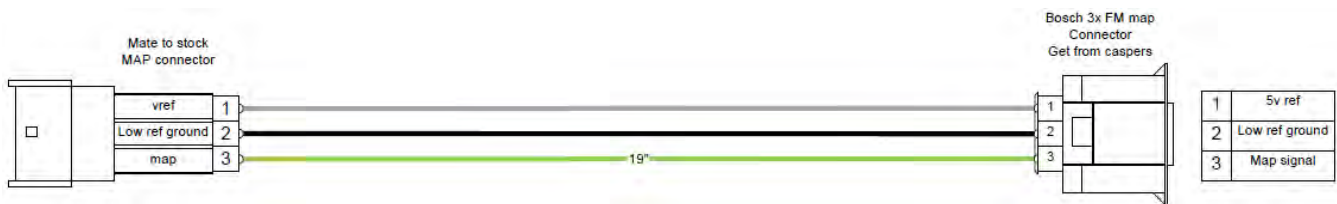

35. Unplug the MAF sensor at air box remove tape and pull back conduit. Remove pin retainer on front and back of plug.

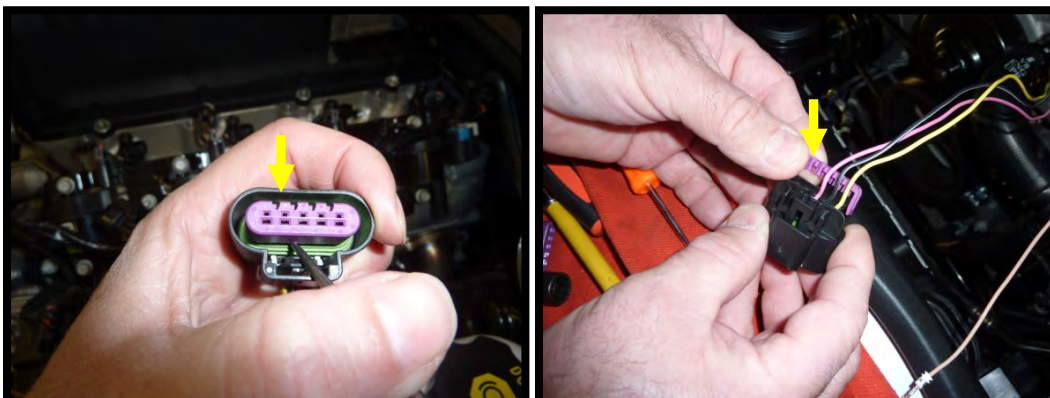

36. Pull **TAN** IAT wires from MAF 5-way connector. Use a pick to pull tab away from terminal to release and push terminal out the back. **NOTE:** 2015 is same as 2009-2014 but colors are WH/BU & BK/VT or (pins D & E 2007-2009 fig B).

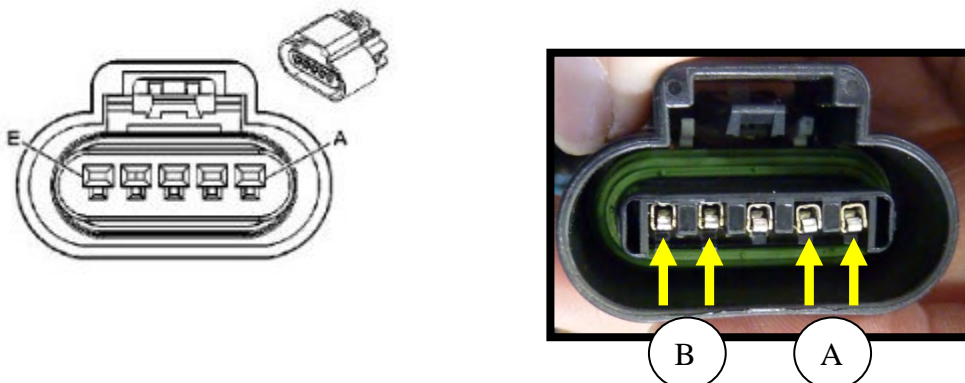

2009-2014 MAF connector

Pin	Wire	Circuit	Function
A	0.5 TN	2760	Low Reference
B	0.5 TN	472	IAT Sensor Signal
C	0.5 YE	492	MAF Sensor Signal
D	0.5 PK	1339	Ignition 1 Voltage
E	0.5 BK/WH	451	Ground

2007 -2009 MAF connector

Pin	Wire	Circuit	Function
A	0.5 YE	492	Mass Air Flow (MAF) Sensor Signal
B	0.5 PK	1839	Ignition Voltage
C	0.5 BK/WH	451	Ground
D	0.5 TN	472	Intake Air Temperature (IAT) Sensor Signal
E	0.5 TN	2760	Low Reference

37. Insert the green cavity plugs provided into empty holes for proper sealing.

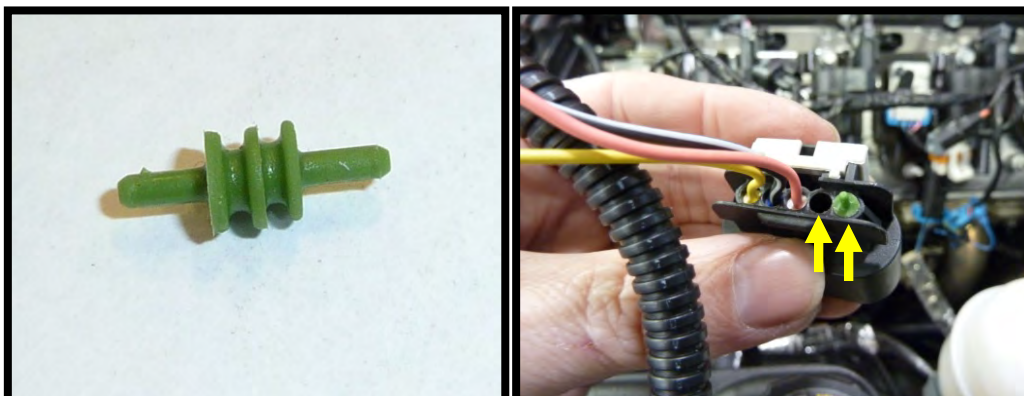

38. Reinstall pin retainers on front and back of MAF plug to secure wires.
39. Insert IAT pins into the back of new 2x plug that came with IAT extension harness (they click in), push purple pin retainer clip down to lock pins in (Note: Polarity is not critical).



40. Pull the IAT wire out of stock harness until it is long enough to reach extension harness to back of the manifold. Re-cover wire harness with supplied conduit.
41. Install the supplied MAF to IAT plug/play harness. One end connects to the MAF, the other end to the supplied IAT sensor.
42. Vehicles equipped with tri-zone AC (RPO code CJ2 on tag in glove box) you will need to bend 1 of the heater lines at the cowl with the tool provided to clear supercharger intake). Remove heater lines at cowl using large quick connect removal tool in kit (A).

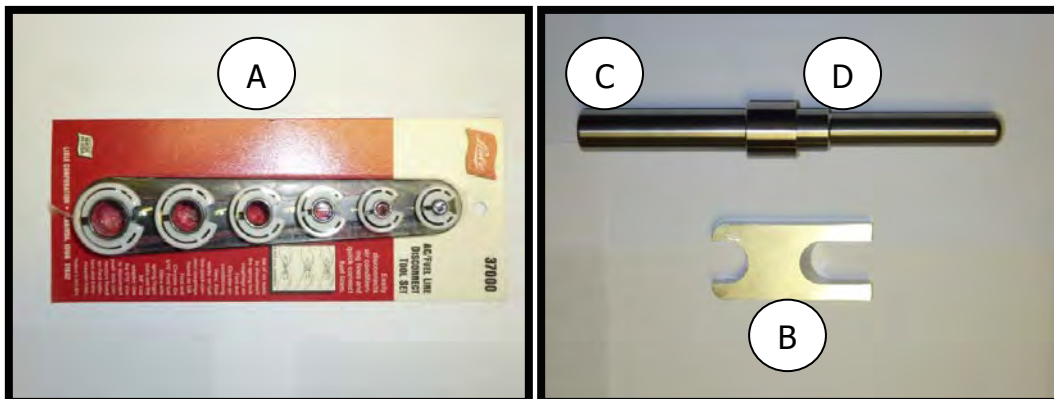

43. Place aluminum brace over lines with rounded end in corner against cowl (B) insert steel shaft (C) into end of tube slide collar (D) over shaft with beveled side against tube and bend in direction as shown until angle matches brace.

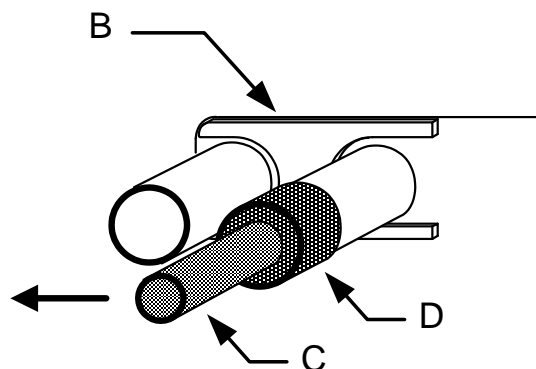

44. Remove EVAP Solenoid from the stock fuel rail by bending tab & lifting up to free the unit.

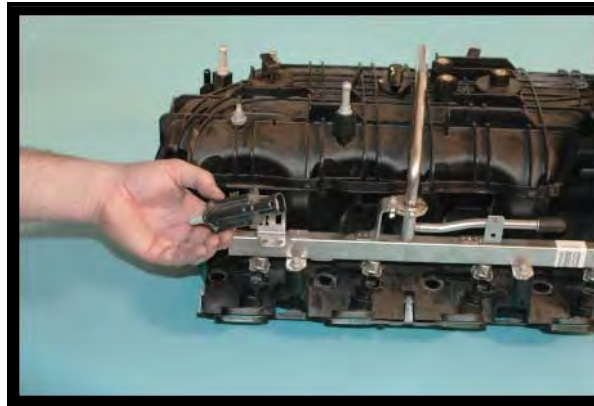

45. (MY2007+ Flex Fuel) Remove the factory fuel injectors from the fuel rail by removing the fuel rail from intake manifold, releasing safety clips and sliding from rails. Clean each injector using light solvent. **NOTE:** If you have over 100,000 miles, its a good idea to have your injectors flowed and tested, along with cleaned if found dirty. New Injectors are also available.
46. Install feed fitting to fuel adapter fitting using supplied 6an oring. Install the (4) in/out fittings to the fuel rail using the 6an oring.

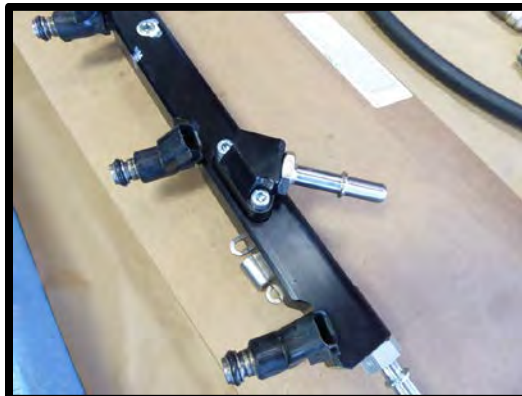

47. Install the supplied fuel rail brackets using the supplied (8) 5mm x 12mm BHCS, leave loose for now. Driver side (feed side), front fuel rail, stack the EVAP solenoid bracket behind fuel rail bracket.

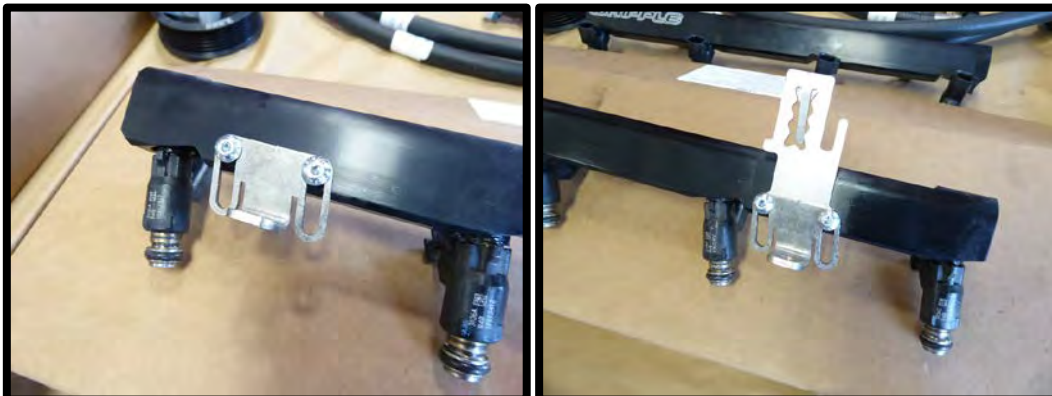

48. Preinstall the fuel injectors to fuel rail, apply light amount of grease/silicone to orings for easy installation.

49. Preinstall the (4) 6AN quick connect fuel fittings into all four ends of the fuel rails. Apply light amount of grease/silicone to oring for easy installation.
50. Disassemble the supercharger assembly from the intake manifold using a 5mm allen socket. Lift the upper manifold out of the lower manifold. NOTE: Be cautious with the bottom of the intercooler core and oring.
51. Install supplied (8) orings too intake manifold using light amount of grease/silicone. These are square orings, do not allow them to twist when installing **(this will cause vacuum leaks)**.



52. Install the supplied intake gaskets to cylinder heads.

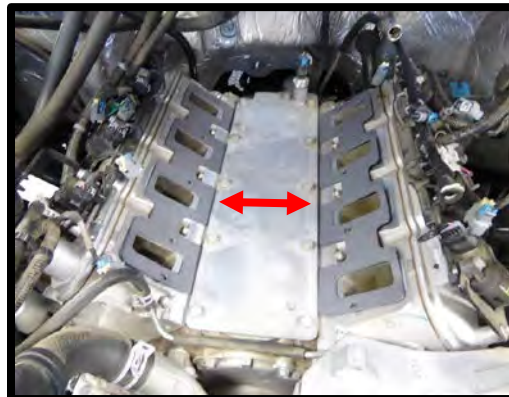

53. Pre-route the supplied fuel cross over line just behind the alternator bracket. Set the intake manifold on the engine, pre-install the supplied (6) 6mm x 80mm SHCS and (4) 6mm 80mm FHCS through the fuel rail brackets and manifold.



54. Apply light pressure on top of fuel rail to seat the injectors. While holding light pressure on fuel rail, from center out, torque the (10) intake manifold bolts to 75 in-lbs.
55. Apply light pressure on top of fuel rail, use a 4mm allen socket, secure the fuel rail brackets to fuel rails.
56. From the center out, torque the (10) intake manifold bolts again to 106 in-lbs.
57. Connect pre-routed fuel line to the front fuel fittings.



58. Connect the factory fuel line to the fuel inlet fitting. Push until it clicks and locks into place. Pull on the connector to check that it is secure, you should not be able to remove the connector unless you use the removal tool. Replace the stainless-steel safety clip that was previously removed.



59. Install the supplied oring to intake manifold, use light amount of grease/silicone to help hold oring in place during SC installation.

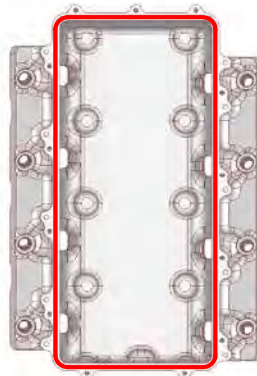

60. Carefully install the supercharger assembly to intake manifold. Pay close attention to the manifold oring and clearance between the fuel rail brackets. Using a 5mm socket, from center out, torque the SC assembly to 96 in-lbs using the (10) 6mm x 22mm SHCS and the (2) 6mm x 30mm SHCS (with (2) 6mm nyloc nuts) in the front two bolt holes.



61. Using a 10mm socket wrench, remove the stock throttle body from the OEM intake manifold.

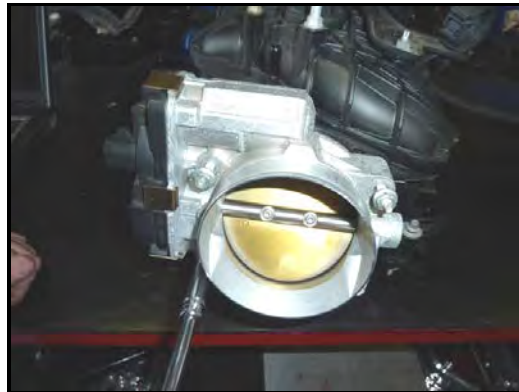

62. A buildup of soot on throttle blade & throat can cause idle problems, clean throttle body with carb spray if sooty.



63. Install the throttle body and supplied TB gasket using the (4) 6mm x 40mm FHCS, torque to 106 in-lbs with a 10mm socket wrench.



64. Install the spring-loaded tensioner to the idler plate using the supplied (1) 12mm x 80mm SHCS and (1) 12mm flat washer. Torque to 28 ft-lbs.



65. Install the idler plate to the engine. Use the supplied (2) 10mm x 60mm SHCS and (1) 10mm x 30mm SHCS to secure to motor. Torque all the bolts to 40 ft-lbs with a 15mm socket.

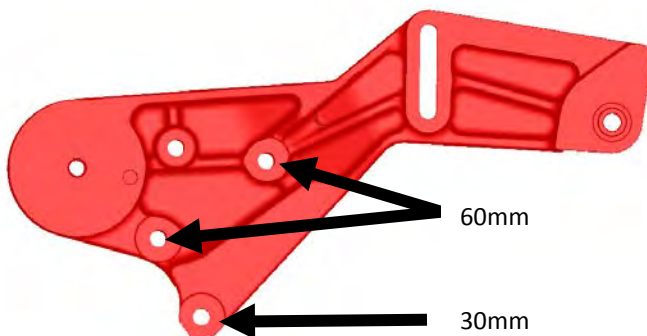

66. Remove the wiring harness from the original bracket



67. Take the eight fuel injector plugs and connect them to the eight fuel injectors. Note: Make sure that the connectors are seated on the injector and locked in place. Pull the harness connector to ensure a good contact.
68. Remove the plastic loom clip from the wire-looms located next to the oil filler neck with a flat blade screwdriver.



69. Plug the electrical connector for the ETC back into the throttle body.
70. Reinstall the brake booster hose to the SC inlet barb fitting. (2009-2014) attach PCV to quick connect fitting.



71. Connect the supplied 1/4" x 36" EVAP hose to 90° fitting on inlet and route around front of blower to EVAP solenoid on driver's side fuel rail.



72. Install the OEM EVAP Solenoid on the mounting bracket on the driver side fuel rail. (A) Connect hose from sc inlet to the front of the EVAP Solenoid. (B) Plug in the electrical connection to the EVAP Solenoid. (C) Plug in the end of the hose with the test port to the remaining (rear) barb on the EVAP Solenoid.

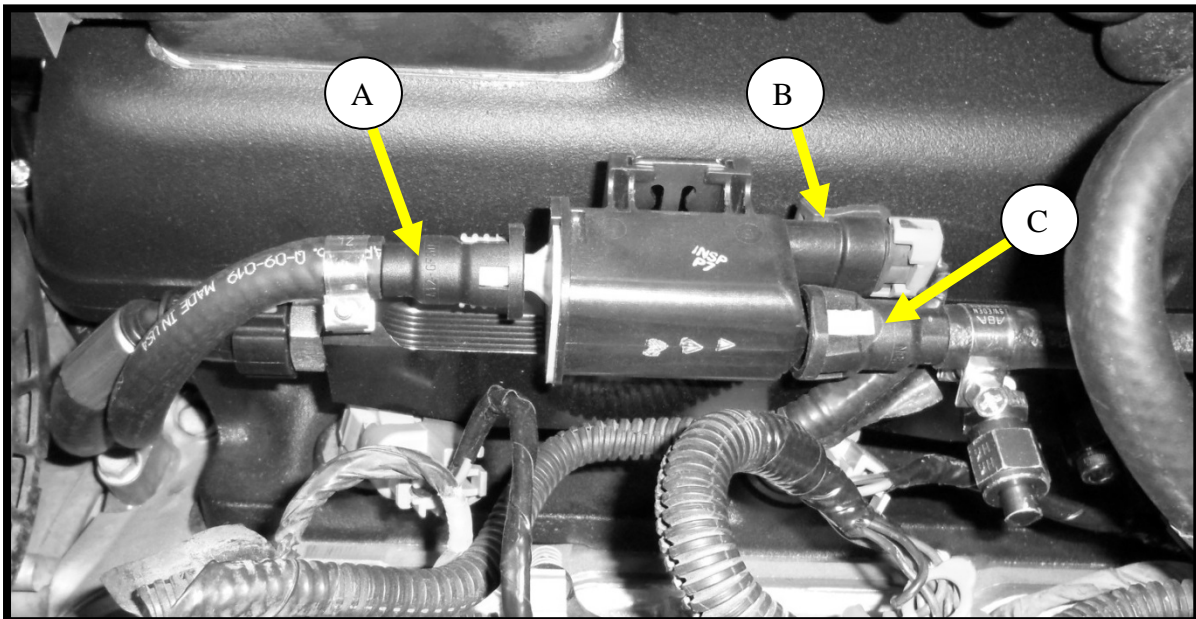

73. Next, re-install the alternator using the factory hardware using a 15mm socket wrench, torque the two bolts to 40 ft-lbs.



74. Ensuring that the battery is still disconnected, connect the battery positive (+) cable you routed in step 93 to the back of the alternator and secure the nut with a 10mm socket wrench and Plug in the Electric-Voltage sensor wire into the Alternator connector as shown.

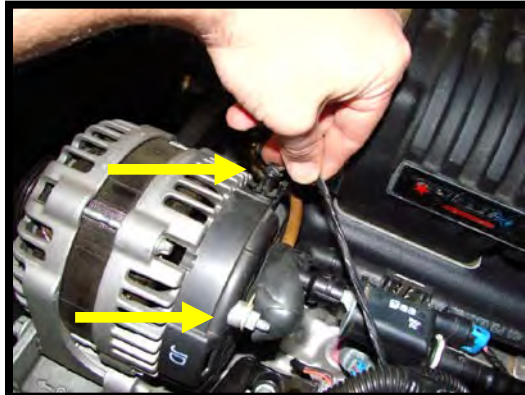

75. Install the supplied smooth idler pulley to the idler bracket. Use the supplied T-Nut on the back-side. Use the supplied .390" step spacer on the back side of the idler pulley. Secure pulley using the step spacer to center the bearing, along with the 1/2" x 2" bolt. Leave loose for now.



76. Install the 2nd smooth idler into the factory location on the alternator bracket. Use the supplied .390" spacer on the back side of the idler. Secure pulley using the step spacer to center the bearing, along with the 10mm x 35mm bolt. Torque to 30 ft-lbs.

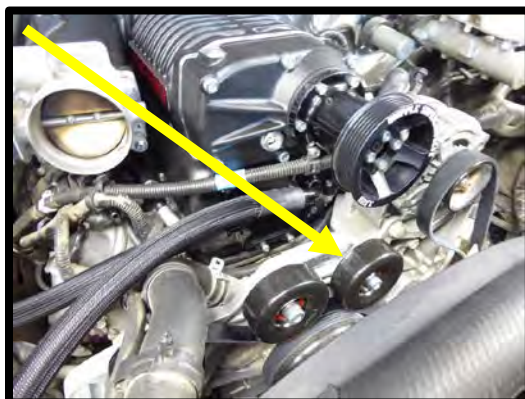

77. Use a 15mm socket wrench to lever the tensioner all the way down, then insert a ¼" extension into existing hole on the tensioner bracket to hold the tensioner in the compressed position.

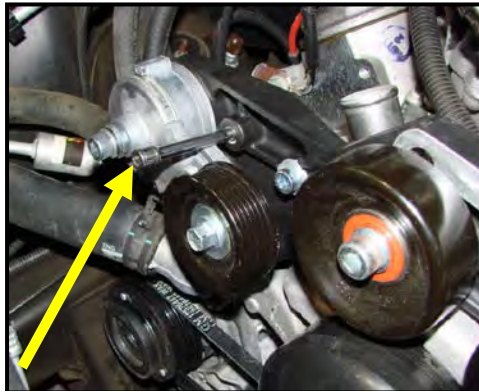

78. Using the belt routing diagram as a guide install the new belt provided. Once the belt is in position slide the sliding idler pulley down and torque to 40ft-lbs using a 15mm socket wrench. Remove the ¼" extension and release the tensioner. Make sure belt contacts all pulleys correctly.

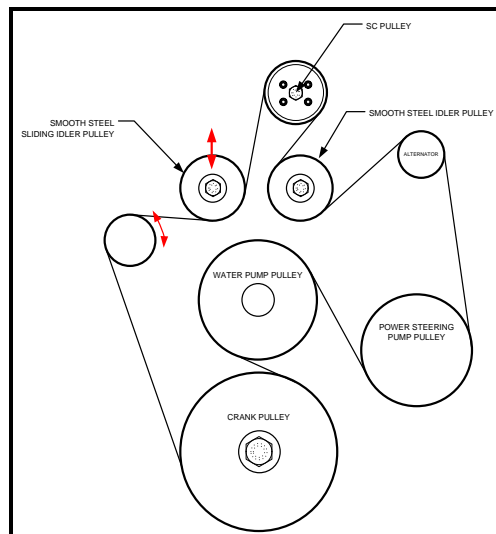

79. Using a T-25 torx socket, remove the four screws that attach the air box lid to the lower half of the air box. Remove the stock air filter from the air box and install the new S&B air filter supplied in the kit

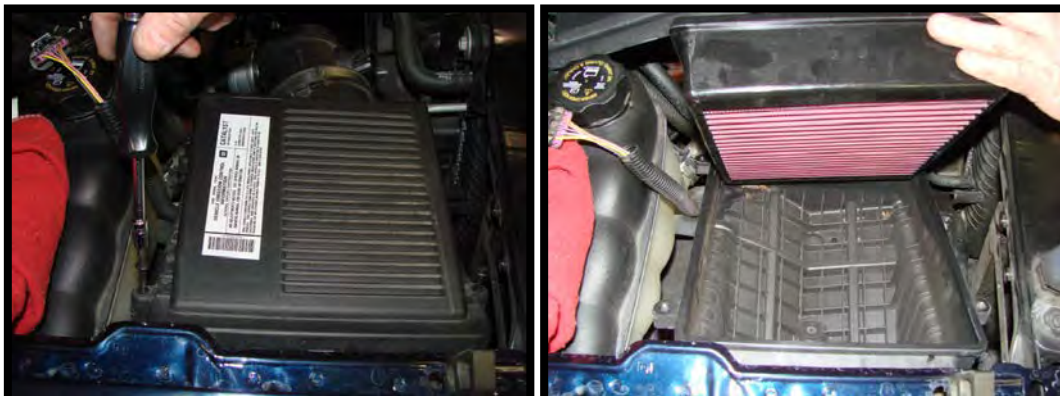

80. Install hump hose on throttle body with clamps then insert end of air tube as shown s silicone spray can be used to help slide parts together. Connect the 90-degree PCV fitting from back of driver's side valve cover to grommet on air tube. Attach the remaining 3/8" hose (left over from a previous step-about 9") from the right (passenger-side) valve cover to the barb on the bottom of the air tube.



81. Install the reducer hose on end of air tube leave clamps loose then slide airbox lid and MAF assembly onto reducer end lower into place adjust position of reducer as necessary then tighten clamps



82. Pull back on the two tabs holding the fuse cover to the fuse box and lift the cover out of the vehicle.



83. The intercooler relay is going to mount on the driver side fuse box. Mount relay on side of fuse box as shown with screws provided, be sure to leave room for fuse box lid to clear relay.



84. Remove the 10amp mini-fuse in the fuse box that labeled **AUX HVAC-IGN**. **NOTE:** Fuse location may vary, verify by fuse name from factory fuse diagram.

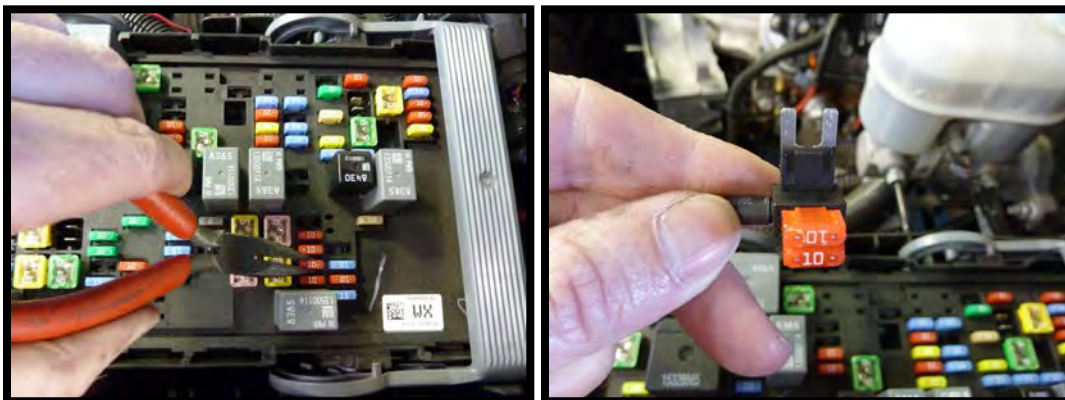

85. Insert fuse tap into fuse socket (**AUX HVAC-IGN**).



86. Using a 12mm socket wrench, and the nut provided, secure the fused red wire to the M8 stud. Remove bolt from aux battery tray in install black ground eyelet. Re-tighten factory bolt.



87. Run the intercooler pump cable under battery tray and behind PCM to front of the vehicle.



88. Now, re-install the fuse cover onto the fuse center. Note: Be careful not to pinch any wires.
89. Secure main wire loom to #1 coil to hold loom in place. Note that the alternator 2-wire connector is tight if loom is not secured properly.
90. Remove the factory support bracket, passenger side inner bolt. Install the intercooler tee bracket using factory bolt. Mount the filler tee to bracket using the supplied (2) 6mm x 12mm BHFCs, the 3/4" and 3/8" nipple faces forward.



91. Remove the radiator support cover from the vehicle using a flat blade screwdriver. Remove the eight plastic pushpins from cover. Remove cover and set aside to be re-installed later.
92. Remove the grille from the vehicle. There are four bolts to remove using a 10mm socket wrench. The grille is held in place with snap-in fasteners, carefully release the retainers and then unsnap the upper bumper insert from the grille releasing the grille from the vehicle. Note: With the grille out, the intercooler pump and LTR mounting can now be done.
93. Heat exchanger assembly image of a pickup (excludes 2008+ SUV).

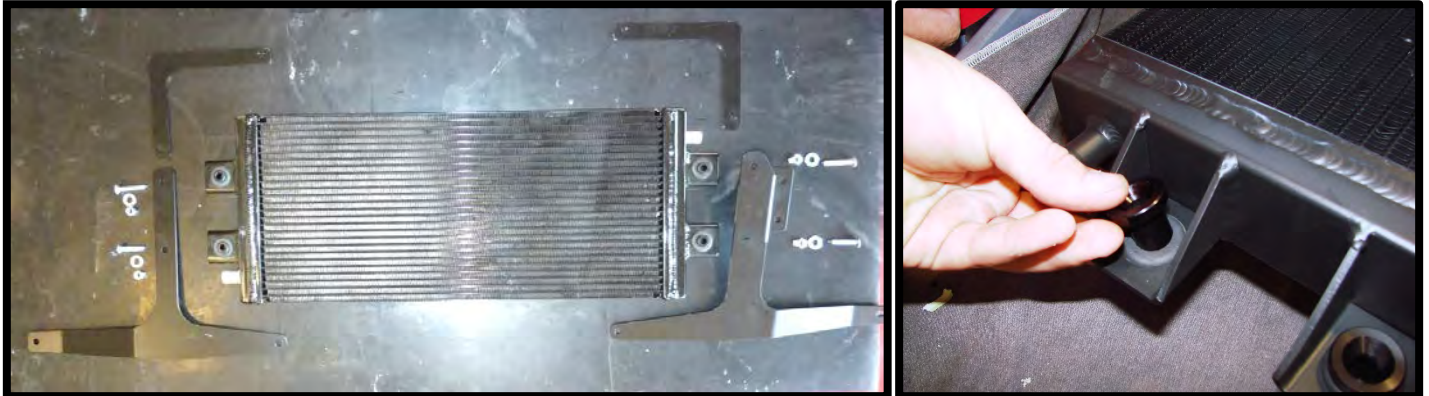

94. Using a scribe, mark the (3) bolts that hold the hood latch assembly so you later can install bolts in identical position.
95. Remove hood latch assembly by removing the (3) bolts with a 10mm socket wrench, then remove (2) bolts from bottom of hood support and remove support from vehicle. Install supplied support bracket in placement of the previous bracket.



96. Install passenger side I/C support bracket using the (2) 8mm x 16mm and (2) 8mm x 20mm HHFCS hardware. (Image shows 2009+ on left and pre-2009 with extension on the right).

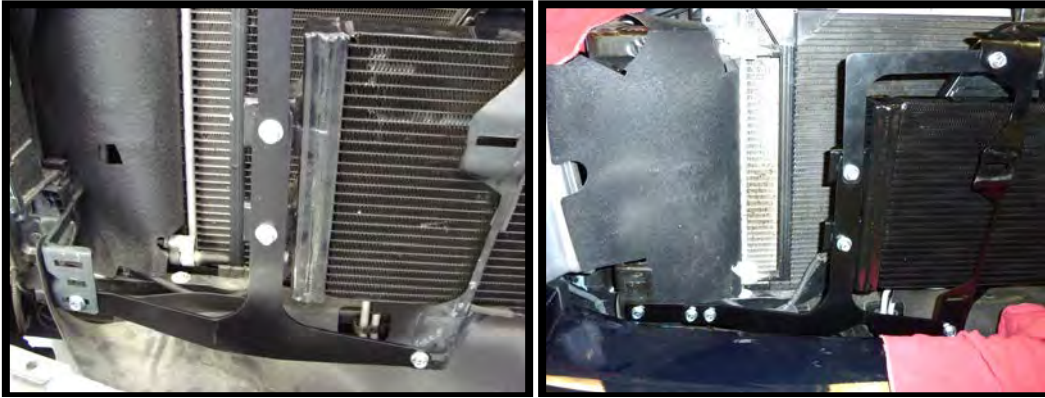

97. Heat exchanger installed for example.



98. Mount the IC pump bracket to the factory bolt just below the passenger side condenser, slightly loosen factory bolt, slide bracket in place (slide from back to front). Secure using stock bolt. Install supplied IC pump clamp to bracket using the supplied (2) 6mm x 12mm HHFCS. Install pump in place, inlet fitting facing up, make sure pump is not hitting/rubbing anything, secure with clamp.

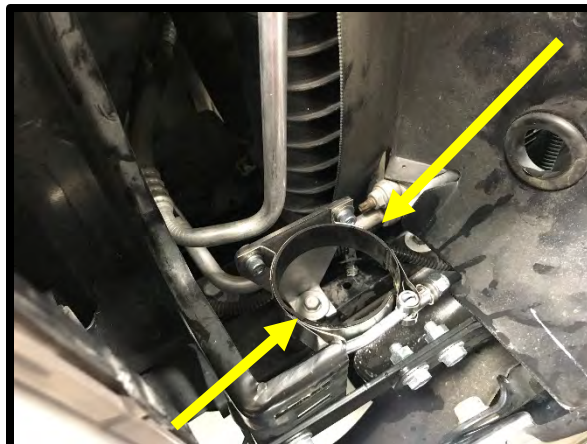

99. Install the intercooler hoses as shown, make a small X or 1" hole through plastic shrouding on the passenger side of radiator for hose routing. *Some trimming may be required for proper hose length fitment. Route the 3/4" x 40" (cut to fit when required) hose from filler tee to IC pump feed, 90deg goes on IC pump. Route 3/4" x 10" hose from IC pump outlet to LTR bottom fitting. Route the 3/4" x 70" LTR outlet hose to the IC inlet fitting, using 90deg push lock fitting at IC core. Route 3/4" x 34" with 90deg push lock fitting from IC core outlet to filler tee inlet (back barb). Route 3/8" vent line down below fender, **do not** route towards exhaust manifold. 90deg push lock fittings do not require clamps, secure all other ends with supplied pinch clamps.

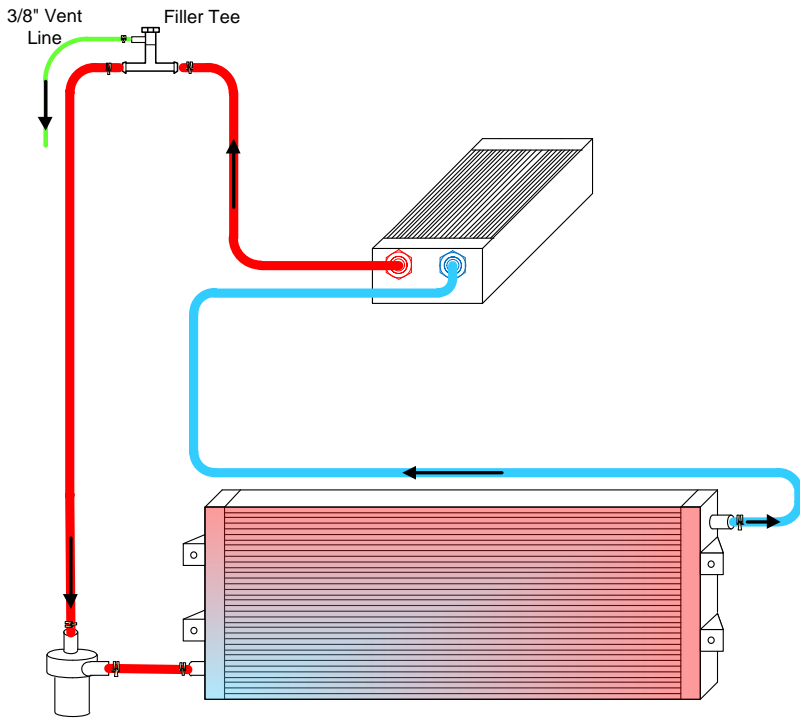

100. (2008+ SUV) Remove grill and bumper cover remove 6 bolts across top of grill leave 2 bolts loose on top remove bolts across bottom of bumper.

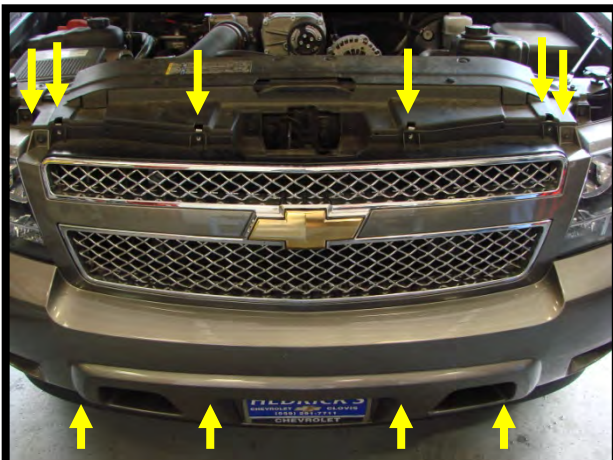

101. (2008-2009 SUV) Remove (2) screws in each wheel well and pop out plastic rivets holding wheel well liner to bumper cover.

102. (2008+ SUV) Pull last (2) bolts at top of grill and lift off bumper cover & set aside (you may need assistance unplugging the driving lights when you pull off).



103. (2008+ SUV) The transmission cooler bracket needs to be modified so the cooler will sit back further to clear the heat exchanger. Unbolt the trans cooler from the bracket, remove the bracket and cut or grind 2 notches as shown. Reinstall cooler bracket and cooler.



104. (2008+ SUV) Mount the IC pump bracket to the passenger side (2) LTR bolts, secure with supplied (2) 8mm nuts. Mount IC pump clamp to bracket using the (2) 6mm x 12mm HHFCS bolts. Install pump into clamp, inlet fitting facing up, tighten clamp. Install the U shape hose assembly to IC pump outlet to heat exchanger inlet, secure both ends with supplied clamps.



105. (2008+ SUV) Set heat exchanger assembly in opening area, align brackets as shown & mark where to drill holes. Install assembly as shown:



106. (2008+ SUV) Install the intercooler heat exchanger install brackets to vehicle. Using the (4) 8mm x 35mm FHCS, secure the conical pin into the rubber grommet, secure other end using supplied 8mm nuts. Secure bracket to vehicle using the (4) 6mm x 18mm HHFCS and 6mm nuts.

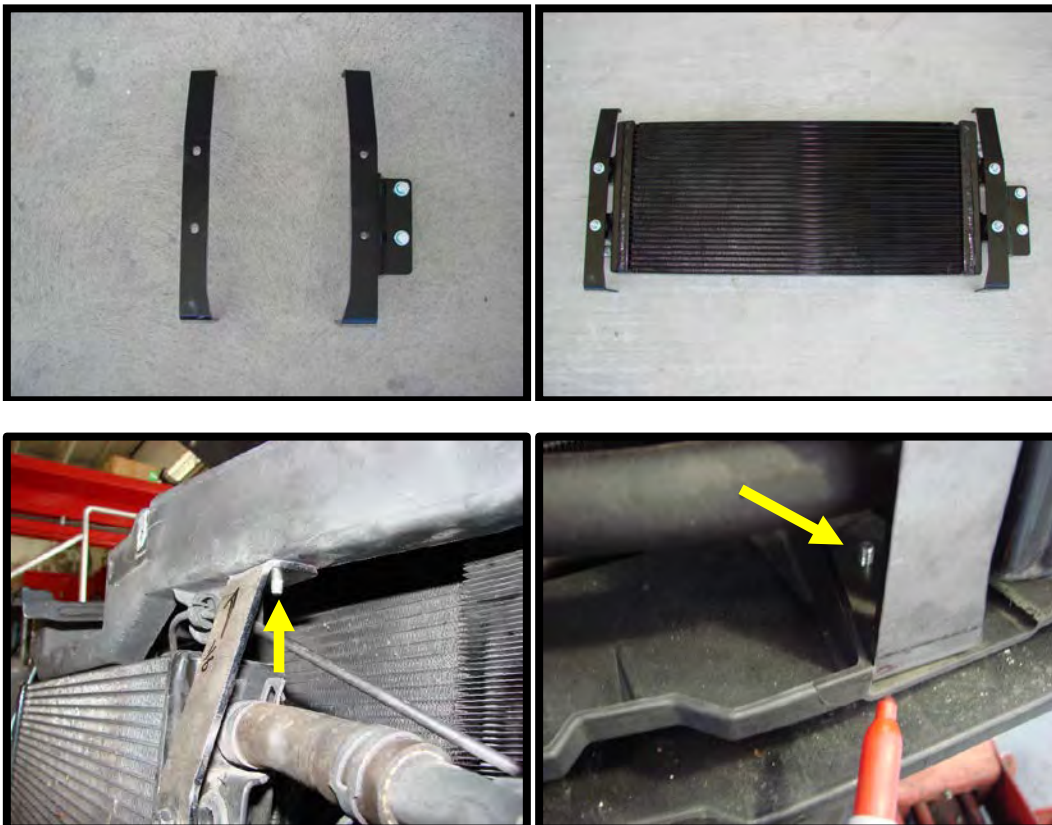

107. Re-install the grille on the vehicle using the stock hardware.
108. Reinstall the radiator support cover on the vehicle using the stock hardware.

109. Fill the new s/c compressor with oil per supplied instructions.

- Make sure the SC is sitting square/flat.
- Remove -4AN allen plug (3/16" allen wrench) and fill SC with **WHIPPLE SC OIL OR OIL ONLY!!**
- Fill to the middle of the sight glass. NOTE: The W140AX compressor takes a maximum of 5.8 fl/oz.
- Reinstall -4AN allen plug.
- NOTE: After running the SC, the oil level will lower due to oil filling the bearings. The proper level while **not running** should be between the bottom of the sight glass and the middle and will vary when running and not running.
- Change SC oil every 100,000 miles and only use **WHIPPLE SC OIL!!**

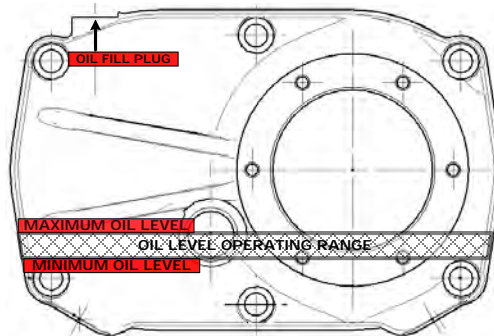

SEVERE DAMAGE TO THE COMPRESSOR WILL OCCUR IF YOU OVERFILL THE SUPERCHARGER FRONT GEAR CASE.

110. Reconnect the battery ground connector with 10mm socket wrench.



The electric water pump used on the Whipple SC system has a built-in micro-processor that will vary pump cycle speed when air bubbles are present in the system. If a significant amount of air is trapped in the system, the pump may cycle at a lower speed and pulsations are likely to occur resulting in poor cooling performance.

For the best result, it is highly recommended to use a Radiator Cooling System Vacuum Purge and Refill Kit to properly evacuate the air from the intercooler system before filling the 50/50 mixture of coolant and distilled water. If one is not available, the following procedure will be adequate.

111. Using a Lisle 24680 Spill-Free Funnel, or equivalent, secure the appropriate filler neck adapter to the filler neck/surge tank.

112. Attach the funnel and fill with a 50/50 mixture of coolant and distilled water until the funnel is half full. Whipple recommends Zerex G-05 to match the stock color. The Whipple IC system is compatible with all common types of antifreeze, it is customer preference. Note: Whipple also recommends 1 bottle of Red Line Water Wetter or equivalent. Never use tap water, this will cause corrosion and destroy the system.

113. Turn the ignition to the **ON** position, after a brief delay, the electric pump motor will cycle. Air bubbles will begin to rise to the filler tee as the coolant level drops, continue to fill while pump is running. Once its done filling, turn the ignition key **OFF**, the level will drop, top off with fluid. Reinstall filler cap and turn the ignition **ON** and let run for 15 seconds. Turn key **OFF**, remove cap to release air. Repeat until the filler tee holds at the cold fill level with key **OFF**. To build more pressure in the intercooler system, try squeezing the filler tee **INLET** hose while the pump is cycling. Building pressure in the system will help push the trapped air from the intercooler system to the filler tee. It also helps to lift the filler neck 4"-8" higher than its mount to help purge the air. **NOTE:** Do not let the coolant level in the funnel run empty as this may introduce more air into the system.



114. Cycle the ignition to the ON position again and repeat until the sound of the electric pump is continuous without any pulsation and the fluid level is met at the filler cap. **NOTE: During water pump start-up, it is normal for a slight pulsation to occur. Once the pump has reached its maximum cycle speed, no pulsations should be present. If any pulsations occur, there is air in the system. NEVER GO WOT UNTIL AIR IS BLED OUT! LISTEN TO THE PUMP, IF ITS VARYING IN RPM, ITS NOT FLOWING CORRECTLY.**
115. Several drive cycles may be required to completely purge the air from the intercooler system. During a drive cycle, the intercooler system will build up pressure as the supercharger temperature increases. Any residual air trapped in the system will have to be bled out when the cap is removed. Use a rag when removing in case there is excess pressure. **TIP: Never go WOT until air has been bled from IC system, engine failure could occur if not bled properly.**

WARNING: Always avoid removing the filler neck cap when the system is hot. The hot coolant is under pressure and may spray out causing burns.

116. Clean the inner area of the gas door with acetone. Attach the "91 OCTANE OR HIGHER" decal to the gas tank fill cap or door.



117. Attach the negative cable to the battery and tighten.
118. Turn the Ignition key on, DO NOT START THE ENGINE. Inspect for any leaks such as fuel, coolant, and intercooler coolant, correct as required.

119. Start the engine and let it idle for 30 seconds and then shut the engine off. Check the SC oil and correct if needed.
120. Start the engine and let it idle. The engine should idle normally between 600-700 rpm. Inspect for leaks. After running for 2 minutes, turn off engine and inspect the level in the engine coolant and intercooler filler tee.
121. Before driving make sure that you have 91 or higher-octane fuel in the system. NOT ½ tank of 87 and ½ tank of 91, ALL 91 or better fuel in the system. DO NOT USE OCTANE BOOSTER IN THE FUEL.
122. DO NOT use aftermarket air filter box or duct with the supplied Whipple calibration. The Whipple calibration is designed to work with the factory air box, factory MAF and Whipple air inlet duct and nothing else. Changes to the air inlet system will require a custom calibration which Whipple does not provide and is not 50-state emissions legal.
123. **(Complete kits only)** Install the supplied 50-state legal sticker to factory radiator shroud or on hood near factory emissions sticker. Clean area with acetone or cleaning agent before installing.
124. Note that the ambient air temp shown on the digital display in the dash takes 2 minutes over 55MPH to reset to read correctly after the PCM has been flashed. It will read 32deg until that time.
125. Test drive vehicle for the first few miles under normal driving conditions. Listen for any noises, vibrations, engine misfire or anything that does not seem normal. The supercharger does have a slight whining noise under boost conditions, which is normal.
126. Re-check the radiator and intercooler reservoir coolant level regularly over the first 1,000 miles, top off level as needed. **NOTE: It is very common for installers to leave air in the system, if pump is varying in RPM, it has air in the system.**
127. After the initial test drive, go through the belt tensioner process again. When next you start driving, gradually work the vehicle to wide open throttle runs. Listen for any engine detonation (pinging). If engine detonation is present, let up on the throttle immediately. Most detonation causes are low octane gasoline still in the tank. Continued detonation can cause engine damage, contact Whipple if you are having this issue.
128. If you have questions about your vehicles performance, please check with your installation facility or call Whipple Superchargers at 559.442.1261, Monday through Friday from 8am to 5:00pm, pacific time or email questions to tech@whipplesuperchargers.com.

△ WARNING!! Verify the bypass actuator is working properly. To monitor, look at the bypass arm when the motor is not running. Start engine and verify that the actuator arm has opened. This arm will be extended when the engine is above 1" of vacuum (boost) and will be open when there is more than 1" of engine vacuum.

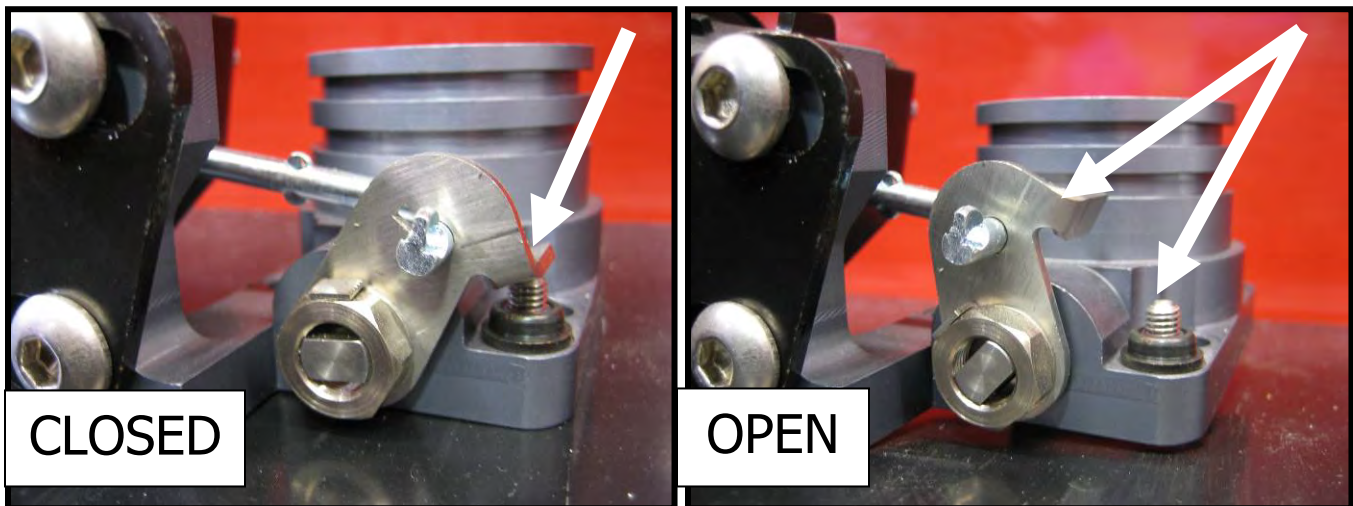

MAINTENANCE AND SERVICE

Be sure to follow the maintenance and service recommendations below to optimize the life and performance of your Whipple-supercharged vehicle.

For best performance and continued reliability, it is essential to adhere to the following guidelines:

1. Use only premium grade fuel (91-octane or higher).
2. Always listen for any sign of spark knock or pinging. If present, discontinue use immediately and consult your vehicle owner's manual.
3. Do not overfill the supercharger front gear case. **NEVER OVERFILL SC, SEVERE DAMAGE WILL OCCUR!**
4. Do not operate the vehicle at large throttle opening if the MIL lamp is on steadily. This indicates an electronic engine control malfunction: reduce throttle opening and consult your vehicle dealer.
5. Inspect and clean your high-flow air filter element every 7,500 miles.
6. Inspect and replace spark plugs every 20,000 miles. Only run specified plugs such as NGK TR7IX.
7. Follow your factory service intervals for oil changes and other typical maintenance items.

!! CAUTION !!

Any modification to your vehicle's new computer program may cause serious damage to the engine and/or drivetrain.

SERVICING YOUR SUPERCHARGER

It is recommended that the following items be inspected at normal service intervals:

1. Check the supercharger oil level at every engine oil change. Add Whipple SC oil to the supercharger if required.
2. Check the supercharger/accessory drive belt. Adjust or replace as required.
3. Change the oil in the supercharger every 100,000 miles. Use Whipple SC oil or oil only. If you change the SC pulley ratio, supercharger oil life will be lowered significantly.

POST-INSTALLATION CHECKLIST

After installing the Whipple supercharger kit it is essential that the following checklist be completed. Failure to complete the post-installation checklist may result in severe engine damage.

1. Review the Maintenance and service section and familiarize yourself with the steps you must take to ensure your Whipple-supercharged vehicle will continue to operate with optimum performance.
2. Verify Fuel Octane: When you re-fuel your vehicle, ensure you use fuel of 91-octane or higher. It will always be beneficial to run 92-94 octane when available.

!! CAUTION !!

Use only 91-octane fuel or higher. If fuel of less than 91-octane is present in the vehicle fuel tank, the tank must be completely drained and refilled with 91 or higher octane to 1/8th of a tank.

3. Check Vehicle Fuel Pressure: Fuel pressure is critical to proper supercharger operation and must be checked during wide-open-throttle operation when the fuel tank is 1/8th full. Fuel pressure should meet all factory specifications.

CHECKLIST REVIEW

Have you completed the Post-Installation Checklist? Be sure you have:

1. Reviewed the maintenance and service recommendations.
2. Verified the fuel octane.
3. Checked the vehicle fuel pressure.
- Have you completed all items in the checklist?

NOTE

There are no warranties expressed or implied for engine failure or damage to the vehicle in any way during supercharger installation or use.

WHIPPLE POST INSTALL DIAGNOSTIC DATA FOR SUPERCHARGER

1. After installing supercharger inspecting MAF g/sec output, timing, timing retard, Inlet Air Temp and Fuel PSI will be at WIDE OPEN THROTTLE (WOT).
2. The LONG FUEL TRIM on Bank 1 (1,3,5,7) & Bank 2 (2,4,6,8) will be @ idle and part throttle. The percent (%) normally is -5 to +10. If you had a -5 to +10 before the supercharger install and now have a +25% after the install, you have a vacuum leak. The best way to find a vacuum leak around the manifold is with a smoke tester. Common codes from a vacuum leak are P0171 and P0174.
3. The normal timing is between 16-18 degrees at WOT. This can vary due to ECT (engine coolant temp) and IAT (inlet air temp) will vary the final timing figure. When you run an engine on a chassis dyno, you want the engine to be @ 160-180 F and the inlet temp to be as low as possible to obtain the highest horsepower/torque numbers. This timing curve is for 91 octane US based fuel. (California 91 with 10% ethanol).
4. Boost is a figure that also vary due to altitude and temperature and the V/E of the engine. The boost number is normally around 8 psi +/- .5 @ sea level. @ 5000 feet its going to be lower, 6psi +/- .5. If you make the exhaust less restricted the boost will go down. If you change the exhaust to an aftermarket exhaust system and it increases the boost, the exhaust its more restrictive. When a catalytic converter is restricted the boost goes up and the engine can start to detonate (ping). This is a very harmful state for the engine and it can damage the connecting rod bearings and the piston.
5. The O2 voltage on B1, S1 (Bank 1 (1,3,5,7) (Sensor 1 before the Cat. Conv.) and B2S1 (Bank2 (2,4,6,8) (Sensor1 before the Cat.Conv.) @ WOT the voltage in millivolts should stay above 850mVolts. NOTE: AIR/FUEL ratio is dependent on the fuel pressure. If the fuel pressure psi goes down the air/fuel ratio will go leaner. Verifying fuel pressure or air fuel ratio is important to the longevity of the engine.
6. Poor fuel quality will result in high timing retard. The ECM will retard the timing as far as possible but will result in audible detonation (pinging). Also, low fuel pressure can cause detonation (lean mixture). Be sure to run premium fuel from a Tier 1 station (Chevron, Shell, Texaco, Unocal, Sunoco, BP, etc). Avoid low cost "Premium" fuel as it does not work nearly as good as proper premium fuel.

COMMON TROUBLE CODES

1. DTC 0171, 0174 are the LEAN trouble codes.
 - a. (P0171 is lean for Bank 1 and P0174 is for bank 2)
 - b. The way the engine sets this code is for the long fuel trims to go over 23% and stay there for 30 seconds
 - c. Another way to set this code is the O2 voltage to stay below .453VDC. The ECM confirms this by adding fuel to the mixture (long fuel trims) this can be caused by octane booster coating the O2 sensor. (Whipple does NOT recommend octane booster). The O2 sensor can fail and not read the richer mixture.
2. The most common way to set the lean codes is a vacuum leak. The oring on the lower intake manifold can detach and cause a leak, omitting the oring at the throttle body is another common place.
3. DTC P0172, P0175 are the RICH codes.
 - a. (P0172 is rich for Bank 1 and P0175 is for bank 2)
 - b. in the 1999-2007 (old body style) truck the long fuel trim only needed to go to -8 and stay there for 30 seconds to set the rich code.
 - c. The new style truck (2007 ½ and up) has to go to -23% to set the code
 - d. The fuel pressure too high can cause a rich DTC, the fuel pressure regulator can be restricted and the pressure can go up over stock. Normal pressure @ idle is 43.5 in mode 1 and 58 psi in mode 2.
 - e. The new body style truck also moves the fuel trims around more than the older forms of ECM (VCM, PCM). The newer computers also use the rear O2's to calculate the fuel trims.

CONGRATULATIONS! YOUR SUPERCHARGER INSTALLATION IS NOW COMPLETE.

IMPORTANT INFORMATION

BOOST LEVELS

All Whipple kits are shipped with approximately 6.5-7.5psi at sea level on stock engines. Additional pulleys are available for lower and higher boost levels, although higher boost levels will void the SC warranty and may need custom PCM calibration. With proper PCM calibration, the factory engine has proven to withstand 10psi before detonation on 91-octane fuel. Engines with other aftermarket upgrades may see slightly lower boost levels due to increased engine airflow.

CAT-BACK EXHAUST SYSTEMS

Whipple recommends a good high flow cat-back exhaust system such as Borla, JBA and many others. Typically, cat-back exhaust systems do not increase the total power output, but typically lowers the exhaust back pressure. This lowers the overall heat the exhaust creates and decreases the overall boost level. In order to see an increase in power, you typically need to go with a smaller SC pulley to get the boost level back up to the previous boost level, which equates to more total power.

EXHAUST HEADERS

A good set of exhaust headers have shown slight increases in power output depending on the application. Headers will also decrease back pressure, which typically lowers the boost level. Most notably, they typically decrease under-hood temperatures and consequently, give the potential for more reliable power. The drop in back pressure decreases heat and helps produce more power. As with the cat-back, the more noticeable gains can be seen when the boost PSI drops and you change the SC pulley to increase the boost PSI back, which gives you more airflow and nets more power.

AIR FUEL RATIO

Air fuel ratio is the measurement of the amount of air and fuel being burned during the combustion process. There are currently many different air fuel-monitoring systems and accuracy is not always guaranteed. Wide band oxygen sensors vary over time and deteriorate with uses of leaded gasoline. Whipple only uses Horiba wide band analyzers and UEGO 6-wire sensors, the most accurate available. Our sensors are checked after every use and transfer functions are changed every time so make sure you're using an accurate meter.

Whipple has found that 12.6:1 is approx. the best a/f for power. Be very careful though, too lean of an air fuel ratio increases cylinder temps and increase the chance of detonation, which is detrimental to engine life. Whipple commonly sets stock motors at approx. 11.75:1 although this varies depending on the application. This is only a rule of thumb because most meters will vary.

FUEL OCTANE

Never run a fuel octane that is below 91octane, (RON+MON)/2. It is recommended, when available, to run 92-94 octane. Never mix mid level (below 91) with 91+, this is very dangerous and can cause severe engine damage. Do not attempt to increase octane ratings with cheap on the shelf octane boosters, these are very hard on spark plugs and many brands do very little to the actual octane rating. The only octane booster we have found that works with no negatives is Boostane. This is the best octane booster found to date has shown to increase the octane rating nearly 2.5 points when mixed at its most concentrated level. Again, this is very hard on spark plugs so constant use will require increased spark plug maintenance and possible cylinder misfire when the plugs foul.

SPARK PLUGS

Whipple highly recommends the use of a colder plug. Whipple has found that the NGK TR7IX plug works very well. We recommend a gap of .035"

FUEL LEVEL

Never operate at WOT when the vehicle fuel levels are below a ¼ tank. Low fuel levels could cause the fuel pump to cavitate and you'll have fuel flow spikes resulting in lean conditions and consequently detonation.



LIMITED WARRANTY

All merchandise manufactured by Whipple Industries has a limited warranty against defects in workmanship and materials to the original purchaser of the Whipple Supercharger System for one calendar year from Whipple Industries ship date. The limited warranty must be signed, dated and returned to Whipple Industries within 30 days of the Whipple Industries ship date and must be accompanied by a copy of the original sales invoice. This warranty is non-transferable.

If an item is suspected of being defective, return it to Whipple Industries for inspection after obtaining the proper Return Authorization Number. If an item is determined to be defective, we will repair or replace it at our discretion within a period of one year from the shipping date on your invoice.

Whipple Industries Inc. limited warranty specifically does not apply to products which have been (a) modified or altered in any way, (b) subjected to adverse conditions such as misuse, neglect, accident, improper installation or adjustment, dirt, or other contaminants, water, corrosion or faulty repair; or (c) used in other than those specifically recommended by Whipple Industries Inc. All products designed for off-road use are considered racing parts and carry no warranty, either expressed or implied, as we have no control over how they are used.

On warranty items, repair/replacements will be limited to parts manufactured by Whipple Industries and will not include claims for labor or inconvenience. All other merchandise distributed by Whipple Industries is warranted in accordance with the respective manufacturer's own terms of warranty. This warranty is expressly made in lieu of any and all other warranties expressed or implied, including the warranties of merchantability and fitness.

Whipple Industries will not be responsible for any other expenses incurred by the customer under the terms of this warranty, nor shall it be responsible for any damages either consequential, special, contingent, expenses or injury arising directly or indirectly from the use of these products.

Whipple Industries reserves the right to determine whether the terms of the warranty, set out above, have been properly complied with. In the event that the terms are not complied with, Whipple Industries shall be under no obligation to honor this warranty. By signing this form, you understand and agree to the terms above.

NAME (Print) _____ ADDRESS _____

SIGNATURE _____ CITY _____ STATE _____ ZIP _____

DATE _____ PHONE _____

SC SERIAL # _____ EMAIL _____
(Found on compressor bearing plate) (Optional)

VIN # _____

CONGRATULATIONS

Your new Whipple Supercharger is engineered to significantly increase your engines power across a broad range of RPM's. It is Whipple's goal to improve your driving experience for many miles and years to come.

Whipple Superchargers operate as an air pump and contain internal rotors that are driven by the engine's crankshaft and serpentine belts. The supercharger compresses outside air and channels it into the engine's intake ports. Because of their design, superchargers may generate some additional noise over the standard, normally aspirated induction system.

At idle, you may hear a medium-pitch rattle from the supercharger main housing. This will diminish at about 400-500 rpm above idle.

You may also experience a muffled high-pitched whine during acceleration. This is caused by the pumping action of the supercharger compressing air and only occurs during boost conditions. It is inaudible during part-throttle acceleration.

These are normal noises associated with any supercharger and have no effect on supercharger performance or engine durability.

Your supercharger is warranted by Whipple Superchargers, please see your terms and conditions on the back of your invoice for more information in regards to the limited warranty. NOTE: Whipple Superchargers will not authorize any warranty repair work or supercharger replacement for normal noises.