



WHIPPLE **SUPERCHARGER** INSTALLATION MANUAL

2015-2023 DODGE HELLCAT, TRACKHAWK, DURANGO, REDEYE
6.2L SUPERCHARGED ENGINE

**PART NUMBERS: WK-3500-S1-30, WK-3500-S2-30, WK-3500-S1-32, WK-3500-S2-32, WK-3505-S1-30,
WK-3505-S2-30, WK-3505-S1-32, WK-3505-S2-32, WK-3515-S1-30, WK-3515-S2-30, WK-3515-S1-
32, WK-3515-S2-32, WK-3600-S1-30, WK-3600-S2-30, WK-3600-S1-32, WK-3600-S2-32**



WHIPPLE SUPERCHARGERS

3292 NORTH WEBER AVE

FRESNO, CA 93722

TEL 559.442.1261

FAX 559.442.4153

WWW.WHIPPLESUPERCHARGERS.COM

PREMIUM FUEL ONLY (91 OCTANE OR BETTER ALWAYS) RON+MON/2

CALIFORNIA AIR RESCOURCE BOARD EXECUTIVE ORDER #D-231-100

INTRODUCTION

Before beginning installation, we encourage you to read this manual thoroughly before you begin any portion of the installation:

1. Please read the installation manual and verify that all items are present. If you are missing hardware or have any questions, please contact your dealer or Whipple Superchargers before you start the installation.
2. Premium fuel (US 91 octane) is required to prevent spark-knock/detonation under certain operating conditions. Other countries must meet US 91 octane standards, RON+MON/2. **If fuel of less than 91-octane is present in the vehicle fuel tank, the tank must be completely drained and refilled with 91 or higher octane to 1/8th of a tank. The fuel system is returnless, therefore, initial fuel in the system will be low octane. Drain all fuel!**
3. Operating your engine without the Whipple Calibration can result in engine damage or failure and will void your warranty.
4. Supply your VIN number (along with gear ratio, transmission type, throttle body type and any changes to vehicle) to Whipple ahead of time so your unique PCM calibration can be built prior to the SC installation to minimize any down time. **NOTE:** Whipple does not support long tube headers, cat removal or any custom modifications. While the vehicle may run correctly, it will no longer be emissions legal and therefore not supported.
5. Instructions reference **LH** (Left Hand) and **RH** (Right Hand) side of vehicle. This is if you're sitting in driver's seat facing forward.
6. **2018 and up require gateway unlock tool (included with complete kits).**

COMPETITION BASED PRODUCT MAY BE USED SOLELY ON VEHICLES USED IN SANCTIONED COMPETITION WHICH MAY NEVER BE USED UPON A PUBLIC ROAD OR HIGHWAY, UNLESS PERMITTED BY SPECIFIC REGULATORY EXEMPTION (VISIT THE "EMISSIONS" PAGE AT [HTTP://WWW.SEMASAN.COM/EMISSIONS](http://www.semasan.com/emissions) FOR STATE BY STATE DETAILS.

COMPETITION BASED PRODUCT IS LEGAL IN CALIFORNIA ONLY FOR RACING VEHICLES WHICH MAY NEVER BE USED, OR REGISTERED OR LICENSED FOR USE, UPON A HIGHWAY.

IT IS THE RESPONSIBILITY OF THE INSTALLER AND/OR USER OF THIS PRODUCT TO ENSURE THAT IT IS USED IN COMPLIANCE WITH ALL APPLICABLE LAWS AND REGULATIONS.

RECOMMENDED TOOLS AND SUPPLIES



Tools

Torque wrench (1/4", 3/8", 1/2") Safety glasses, metric wrench set, 1/4", 3/8", 1/2" assorted metric socket set, 3/8" assorted metric allen socket set, T30 torx socket, flat head screw driver, 5/16" nut driver and drain pan (for coolant).

Tie Straps

These will be useful for securing the wiring harness away from the installation area as directed in the instruction manual. They are inexpensive and will be very handy during installation.

Sealants

Blue Loctite™ #242 or equivalent and Red Loctite™ #271 or equivalent. All bolts that need Loctite™ are marked with:  **Loctite™ (#242 blue) threads,**  **Loctite™ (#271 red) threads.** Thread sealant such as pipe teflon must be used on all pipe threads.

Chemicals and lubricants

You will need some cleaner/degreaser such as carb cleaner. Motor oil and clear automotive-type grease will be useful as a lubricant and should be readily available during installation.

Clean Shop Towels

Use these to keep the installation area clean.

WARNING!!

MODIFYING THE SUPERCHARGER OR THE SUPERCHARGER SYSTEM CAN RESULT IN RELIABILITY OR FAILURES.

WELDING:

Welding onto precision components for Nitrous rails is extremely dangerous and will most likely lead to unwanted noises and/or failures. The supercharger system is designed and manufactured to very tight tolerances, welding on the part can cause unwanted distortion. Distortion on any part of the supercharger system can distort in many other areas and greatly affect the life of the SC. If the product is found to have distortion due to this modification and this created an issue, this will void the warranty.



NITROUS SPACER PLATES:

Certain spacer plates have improper oring glands, meaning the width and depth of the grooves are not specified correctly to the 16 orings supplied. This causes severe distortion to the supercharger housing. Never run these spacer plates with the supplied orings. It is recommended that you run two sets of Cometic/Whipple AFM gaskets. Any plate should be validated flat with flatness checked prior. Flatness should be less than .002" per 12" in length. The bridge between spacers can also allow significant warpage, while also potentially sitting proud of the sealing surface. Ensure no bolts create interference with the supercharger housing or list can lead to uncontrolled distortion.



MODIFIED MOTORS:

Modified motors can create another issue. Improper decking of the heads or block could create uneven surfaces between manifold mounting flanges. Ensure flatness is less than .002" per 12" in length from front to back and at no time are the head surfaces within .003" of each other (bank to bank).

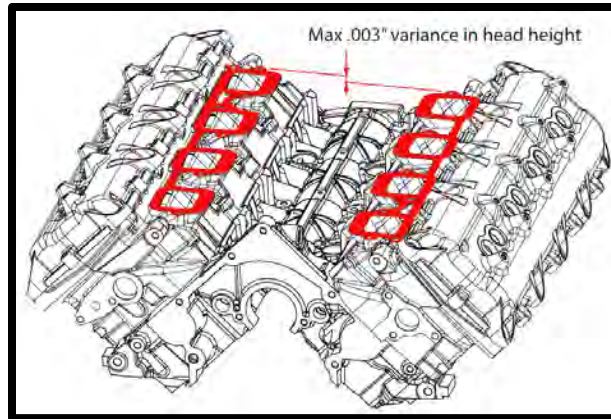

PORTING:

Disassembling and modifying the supercharger can create multiple issues and can void warranty if the failure is caused by the modifications. The only approved porting service is from Whipple Superchargers or Kong Performance.

GASKETS:

Whipple has found that the only two options for gaskets are OEM stock stamped steel gaskets (with plastic retainer removed) OR the **Cometic AFM** coated metal gaskets. The AFM gasket is a chemically blown; compounded nitrile synthetic rubber bonded to an aluminum core. AFM material has an 85% recovery while maintaining strong torque retention. AFM does not require sealants or re-torquing. Paper type gaskets allow significant flex of the supercharger which can destroy the supercharger.

PRE-INSTALLATION CHECKLIST

Before installing your Whipple Supercharger Kit, complete the following checklist.

1. Verify Condition of Vehicle: Before the supercharger kit is installed, ensure the engine runs smoothly and that the factory malfunction indicator light (MIL) is off. Only install the supercharger kit if the engine runs smoothly *and* the MIL is off.
2. **!! CAUTION !!** This product is intended for use only on STOCK, UNMODIFIED, WELL-MAINTAINED engines. Installation on a worn-out is not recommended. Custom engine configurations require custom tuning and other supporting modifications which is not emissions legal.
3. **!! CAUTION !!** Use only 91 octane fuel or higher. If fuel of less than 91-octane is present in the vehicle fuel tank, the tank must be completely drained and refilled with 91 or higher octane to 1/8th of a tank.
4. Verify Fuel System: Supercharger systems should only be installed on vehicles that have new or clean fuel filters. **Never operate at wide open throttle when fuel level is below ¼ tank. Fuel flow cannot be maintained if the pump runs dry.**
5. Assess Cleanliness of Installation Area: Make sure your work area and the under-hood area are free from debris. This supercharger is a high-quality, close-tolerance compressor and must not be subjected to contamination by dirt or any type of foreign material. If necessary, vacuum around engine to remove any foreign material.
6. **!! CAUTION !!** **DO NOT** remove the protective seal on the supercharger prior to installation. Foreign material entering the supercharger will automatically void all warranties.
7. Identify Supercharger Kit Components: Before beginning installation, identify all the components of your Whipple Supercharger Kit and ensure all items are present and undamaged.
8. **!! CAUTION !!** Do not attempt to start the engine before adding the supplied supercharger oil to the supercharger!

SAFETY PRECAUTIONS



CAREFULLY READ THE IMPORTANT SAFETY PRECAUTIONS AND WARNINGS BEFORE PROCEEDING WITH THE INSTALLATION!

Appropriate disassembly, assembly methods and procedures are essential to ensure the personal safety of the individual performing the kit installation. Improper installation due to the failure to correctly follow these instructions could cause personally injury or death. Read each step of the installation manual carefully before starting the installation.

- Always wear safety glasses for eye protection.
- Place the ignition switch in the off position.
- Always apply the parking brake when working on vehicle.
- Block the front and rear tire surfaces to prevent unexpected vehicle movement.
- Operate the engine only in well-ventilated areas to avoid exposure to carbon monoxide.
- Do not smoke or use flammable items near or around fuel system.
- Use chemicals and cleaners only in well-ventilated areas.
- Batteries can produce explosive hydrogen gas which can cause personal injury. Do not allow flames, sparks or flammable sources to come near the battery.
- Keep hands and any other objects away from the radiator fan blades.
- Keep yourself and your clothing away from moving parts when the engine is running.
- Do not wear loose clothing or jewelry that can be caught in rotating or moving parts.

Symbol Key

Throughout this installation guide you will see the following symbols used:

NOTE

Used to indicate tips and information to aid in installation, maintenance, or use of the supercharger.

!! CAUTION !!

Used to indicate precautions that must be taken to avoid damage to the supercharger and associated components.

WARNING!!

Used to indicate precautions that must be taken to avoid bodily injury as well as damage to the supercharger and associated components.

COMMON ABBREVIATIONS

ABBREVIATION	DESCRIPTION
DTC	Diagnostic Trouble Code
ECT	Engine Coolant Temperature
EGR	Exhaust Gas Recirculation
ETC	Electronic Throttle Control
EVAP	Evaporative emissions system
FHSCS	Flat Head Socket Cap Screw
HHFCS	Hex Head Flanged Cap Screw
IAT	Inlet Air Temperature
IC	Intercooler
ID	Internal Diameter
LB-IN	Pound-force inch
LB-FT	Pound-force foot
LH	Left Hand Side (from driver seat)
LTR	Low temp radiator
MAF	Mass Air Flow
MAP	Manifold Absolute Pressure
MY	Model Year
OBD	On Board Diagnostics
OD	Outside Diameter
PCV	Positive Crankcase Ventilation
PSI	Pound per Square Inch
RH	Right Hand Side (from driver seat)
SC	Supercharger
SHCS	Socket Head Cap Screw
TPS	Throttle Pressure Sensor
TRQ	Torque

➤ NOTICE

NEVER WELD ONTO SUPERCHARGER IN AN WAY, SHAPE OR FORM. THIS WILL CAUSE DAMAGE TO SUPERCHARGER AND VOID ANY AND ALL WARRANTIES!!

DISASSEMBLING SUPERCHARGER BY ANY UNAUTHORIZED PERSONAL WILL VOID ANY AND ALL WARRANTIES.

RUNNING UNSUPPORTED PERFORMANCE PARTS SUCH AS NITROUS SPACERS, NITROUS JETS, ETC CAN VOID WARRANTY IF DAMAGE IS CAUSED BY UNSUPPORTED MODIFICATIONS.

NEVER RUN NITROUS OUTLET OR OTHER TYPE OF NITROUS SPACERS WITHOUT PROPER ORINGS OR GASKETS. CYLINDER HEADS AND/OR SPACERS ARE REQUIRED TO BE FLAT WITH A MAX VARIANCE OF .001". USING SPACERS WITH WRONG ORINGS WILL CAUSE EXTREME CASE DISTORTION AND EVENTUAL FAILURE.

MODIFYING THE SUPERCHARGER AND SUPERCHARGER SYSTEM CAN VOID WARRANTY IF DAMAGE IS CAUSED BY UNSUPPORTED MODIFICATIONS.

➤ NOTICE

The installation of Whipple Supercharger products signifies that you have read this document and have agreed to the terms stated within.

It's the purchaser's responsibility to follow all installation instruction guidelines and safety procedures supplied with the product as it's received by the purchaser to determine the compatibility of the product with the vehicle or the device the purchaser intends to install the product on.

Whipple Superchargers assumes no responsibility for damages occurring from accident, misuse, abuse, improper installation, improper operation, lack of reasonable care or all previously stated reasons resulting from incompatibility with other manufacturer's products.

There are no warranties expressed or implied for engine failure or damage to the vehicle in any way, loss of use or inconvenience or labor reimbursement. This includes merchantability and fitness.



⊘ *NEVER SMOKE DURING THE INSTALLATION OF THE SC, THERE WILL BE FLAMMABLE FUMES AND LIQUID AROUND THE VEHICLE*

SUPERCHARGER INSTALLATION INSTRUCTIONS

It is strongly recommended that you read through this guide **before** you begin installing the Whipple Supercharger.

⚠ WARNING!! Batteries normally produce explosive gases. Therefore, do not allow flames, sparks or lighted substances to come near the battery. When charging or working near a battery, always shield your face and protect your eyes. Always provide ventilation. Failure to follow these instructions may result in personal injury.

⚠ WARNING!! Keep out of the reach of children. Batteries contain sulfuric acid. Avoid contact with skin, eyes or clothing. Also, shield your eyes when working near the battery to protect against possible splashing of the acid solution. In case of acid contact with the skin or eyes, flush immediately with water for a minimum of 15 minutes and get prompt medical attention. If acid is swallowed, call a physician immediately. Failure to follow these instructions may result in personal injury.

1. (Complete kits only) **DO NOT START INSTALLATION UNTIL PCM IS UNLOCKED (2015 AND UP) AND CALIBRATION HAS BEEN SUPPLIED.** Follow the included flash tool, read/write Whipple instructions included. Note: Make sure your battery is fully charged before installing, if not, install a battery charger to maintain 14volts. Modified engines such as long tubes, camshafts or oversized throttle bodies are not supported. Calibrations take 24-48 hours to build, make sure to do this before installation. Flash the PCM prior to starting installation. In rare cases, a PCM strategy may not be supported.
2. Using an air hose, blow off any loose dirt or debris from engine compartment. If really dirty, then steam clean the engine compartment before proceeding to the next step.
3. Slowly remove the factory gas cap to relieve any excess pressure.
4. Open the trunk and remove the lift up panel to gain access to the battery.



5. With a 10mm wrench disconnect the (-) negative battery cable. Make sure the cable is far enough away from the battery that it does not accidentally touch the battery and make connection during the installation.
6. Using the factory mounting points, jack the vehicle up and install 4 jack stands at an ideal height of 18".
7. Lift and remove the factory plastic valve cover covers.
8. Using a label maker, masking tape or some other means of marking, mark each MAP sensor 4-way **CONNECTOR** and its location (NOT THE TMAP SENSORS). Note: All (4) 3-bar map sensors are all the same sensors therefore they can be mixed, but wiring is critical to keep in the correct location.
 - Sensor #1 = Pre-SC, inlet pressure sensor (SIP). Passenger side inlet. (1 = blue/green, 2= blue/tan, 3 = yellow/red, 4 = purple)
 - Sensor #2 = Post SC, Pre-intercooler. Driver side lid. (1 =blue/green, 2 = purple/blue, 3 = yellow/red, 4 = purple/yellow).
 - Sensor #3 = Post SC, Post intercooler, Driver side. (1 =blue/green, 2 = blue/light blue, 3 = yellow/red, 4 = brown/pink).
 - Sensor #4 = Post SC, Post intercooler, Passenger side. (1 = blue/green, 2= blue/green, 3 = yellow/red, 4 = brown/blue).
9. Disconnect MAP sensor on top of intake manifold (post SC, pre-IC).

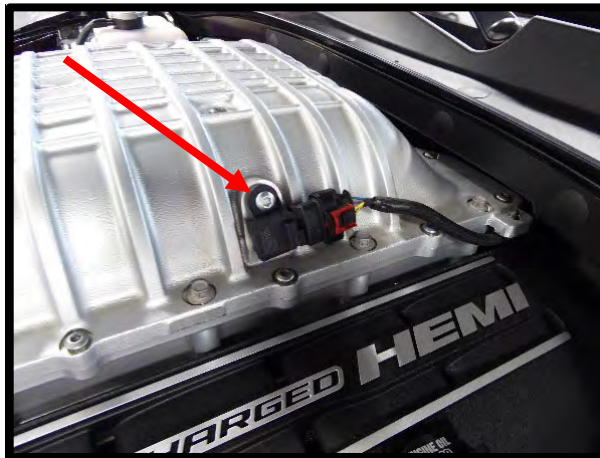

10. **(2015-2016 Only)** Disconnect MAF sensor connector from MAF housing. **NOTE:** 2017+ doesn't use MAF sensor.

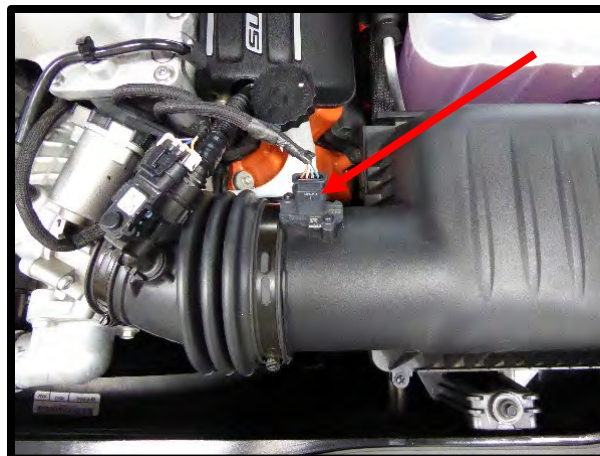

11. (When applicable) Disconnect inlet crank case pressure sensor from air duct tubing.

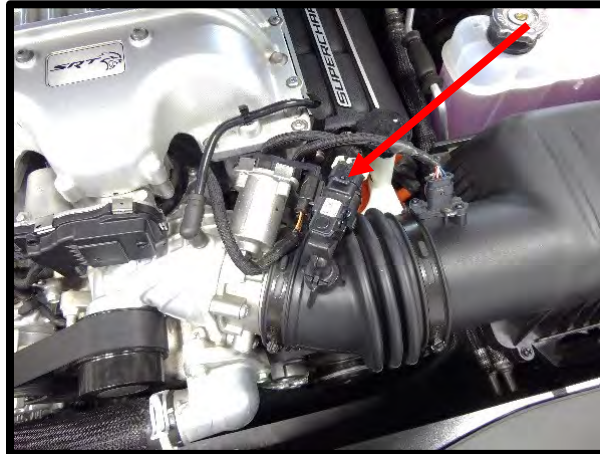

12. Disconnect the drive by wire connector from stock throttle body.

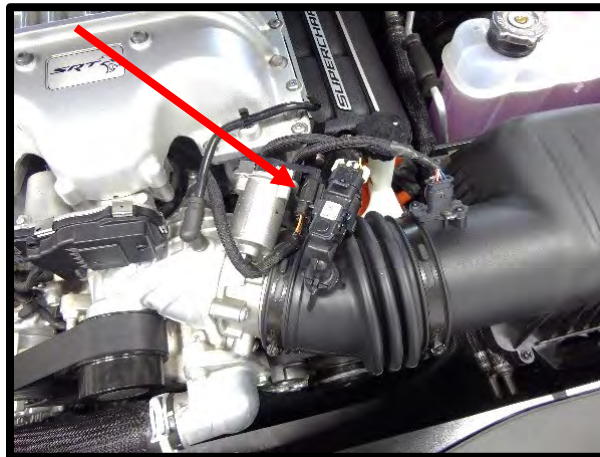

13. Disconnect inlet pressure sensor on supercharger inlet.

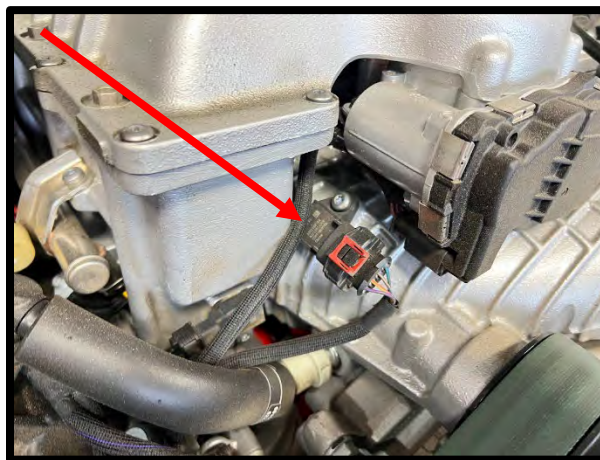

14. Remove EVAP vent line from supercharger inlet duct. Release vent line from plastic clamp located on intake manifold.



15. Disconnect and remove the driver side valve cover to air inlet tube hose. Remove sensor and 90deg plastic assembly from tube by lightly rotating and pulling. This part will be reused. (2017+ Hellcat/Redeye and 2019+ Trackhawk/Durango) Use a razor blade, cut the factory nylon hose from crank case sensor barb, this hose will be replaced.

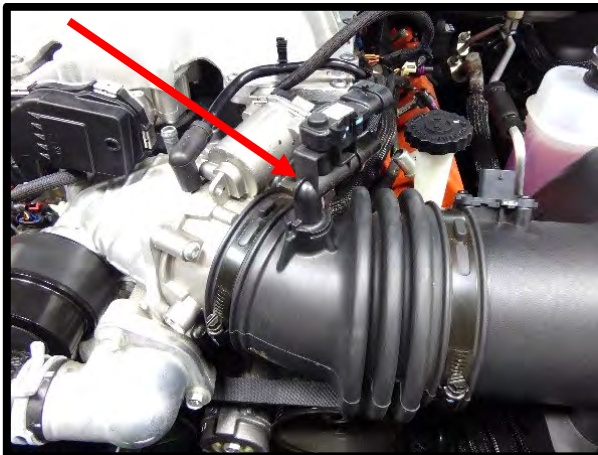

16. (Hellcat) Using a 5/16" nut driver, loosen the clamps on the rubber air tube between airbox and supercharger. Using the same tool or a phillips screw driver, remove the (3) airbox bolts on standard Hellcats. Remove air tube out of the way. Standard Hellcats, remove air box lid and air filter from vehicle.

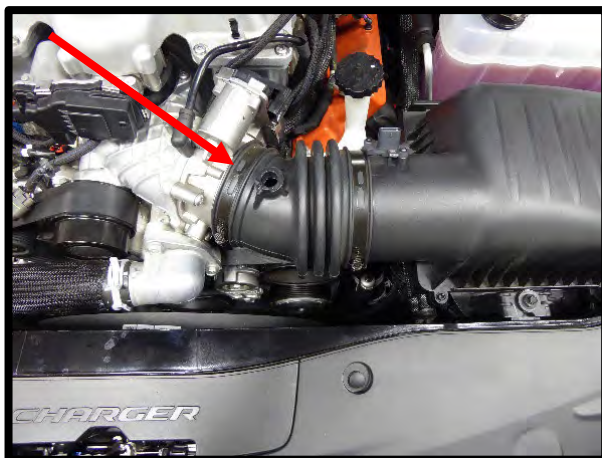

17. **(Redeye)** Using a 5/16" nut driver, loosen the clamps on the rubber air tube between airbox and supercharger. Remove inlet tube from engine. Remove the (4) torx bolts securing filter to airbox, remove filter from box.

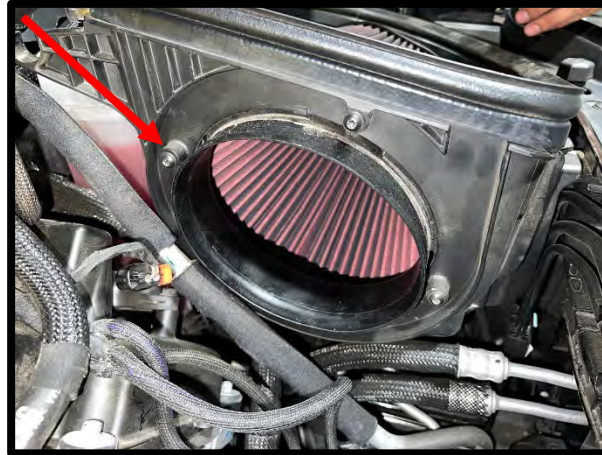

18. Using a 5/16" socket, remove the (1) retaining bolt for airbox lower. Lift the airbox back and up, disconnecting snorkel at the same time. **NOTE:** Redeye version, fascia needs to be removed to get snorkel out.

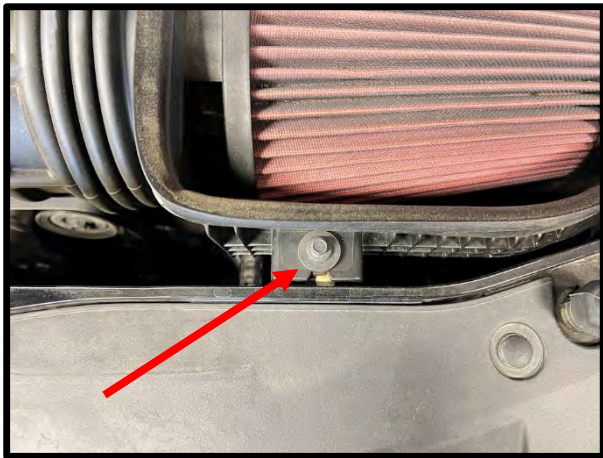
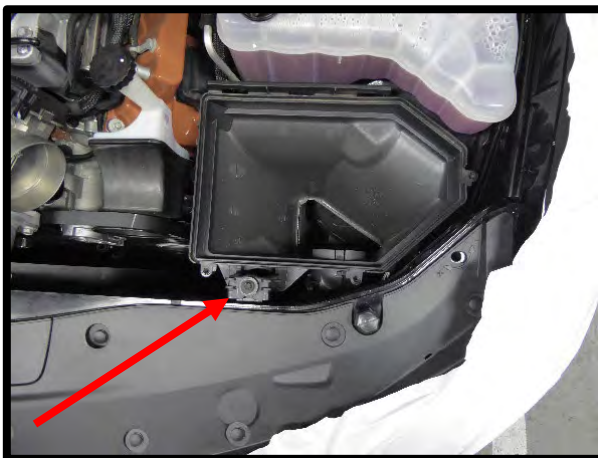

19. Remove stock cold air snorkel from airbox for later installation to Whipple airbox.



20. Remove passenger side valve cover to SC inlet PCV vent line.



21. Remove the throttle body from the engine using a T30 Torx and socket wrench.

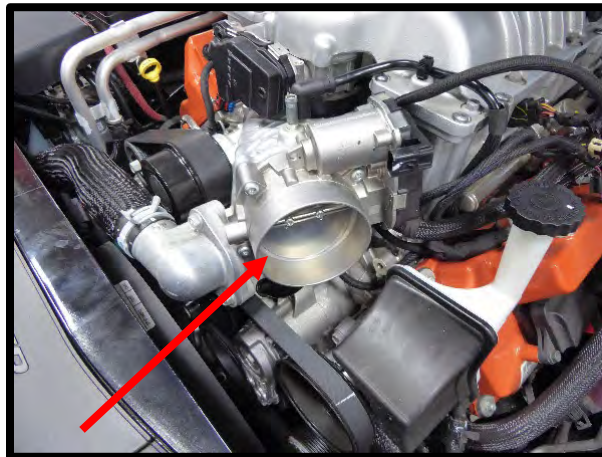

22. Remove brake booster hose from supercharger inlet.



23. Using a 3/8" breaker bar or ratchet, release tension from the factory 6-rib spring loaded tensioner. Remove belt from the engine (this will be reused).

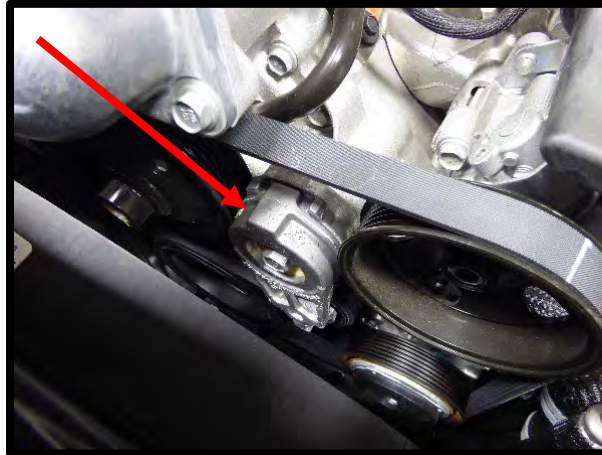

24. Using a 15mm socket, release the tension from the supercharger spring loaded tensioner. Remove the supercharger belt from the engine.



25. Mark the wiper position for easy reinstallation. Remove the windshield wipers from the vehicle. Use a razor or thin gasket scraper to carefully lift the plastic cover. Use a 15mm socket to remove factory nut (this will be reused).



26. Remove the cabin air filter cover from plastic cowling.

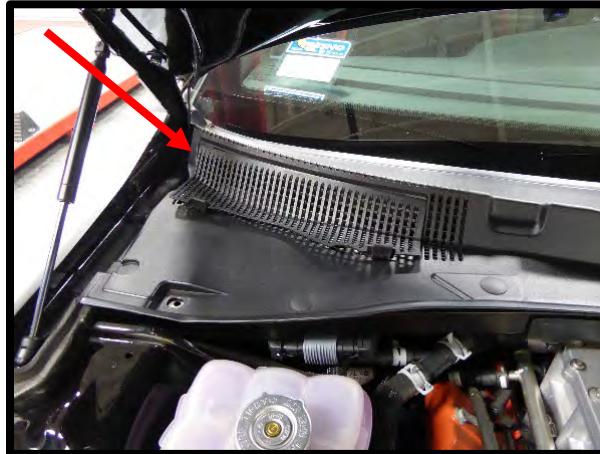

27. Remove the plastic cowling from the vehicle by removing the (8) push pins. Note there are (2) tabs on each side, pull towards center to release tabs before lifting away. Remove the wiper motor cover, this can only be reused if cut to fit.

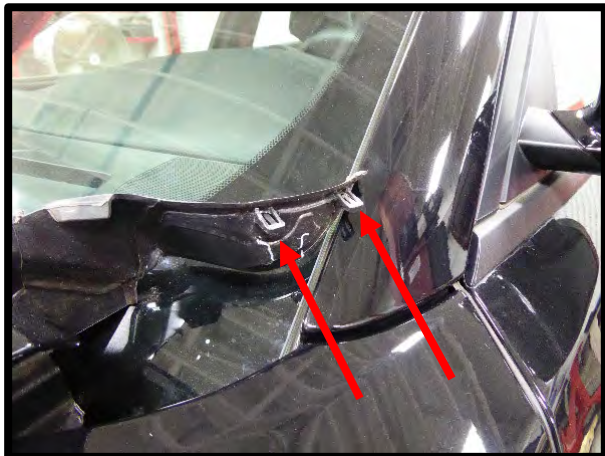
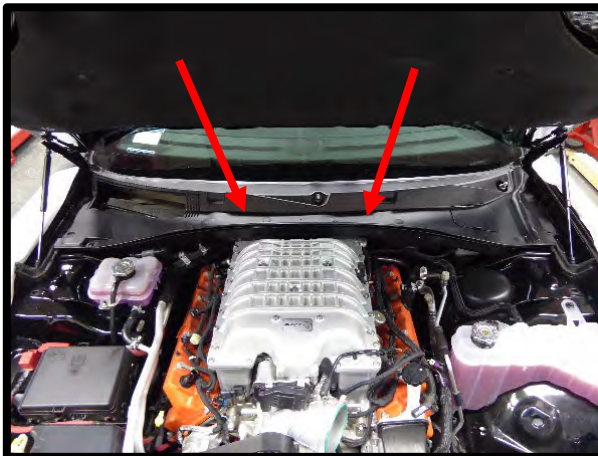

28. Remove the (6) push pins from cowl cross brace.



29. Remove the (4) factory fasteners from cowl cross brace using a 13mm socket (2 per side).



30. Disconnect the (2) intercooler lines by removing the factory pinch clamps. Lower fitting, remove from intercooler fitting. Top fitting, remove just after the factory Y fitting. Clamp the lines with a hose crimp plier to limit leaking.

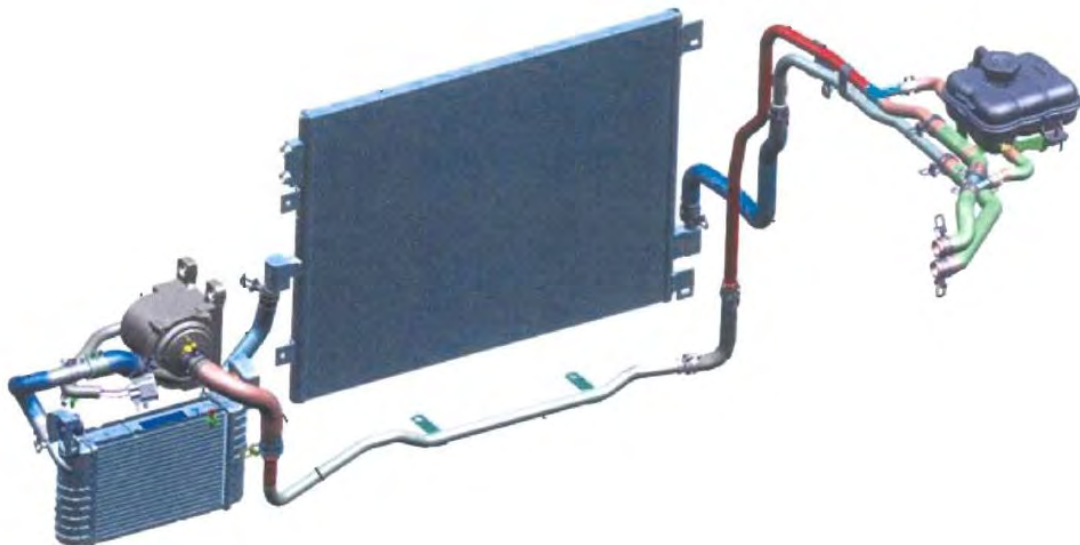

31. Disconnect intercooler water temp sensor connector at the back of the supercharger assembly.



32. Carefully disconnect factory fuel line. Caution, this could be under pressure, use a rag to protect from spray.



33. Disconnect all (8) fuel injector electrical connectors.

34. Using a 10mm socket, remove the (10) factory fasteners from the supercharger housing. Lift and remove supercharger housing from engine.

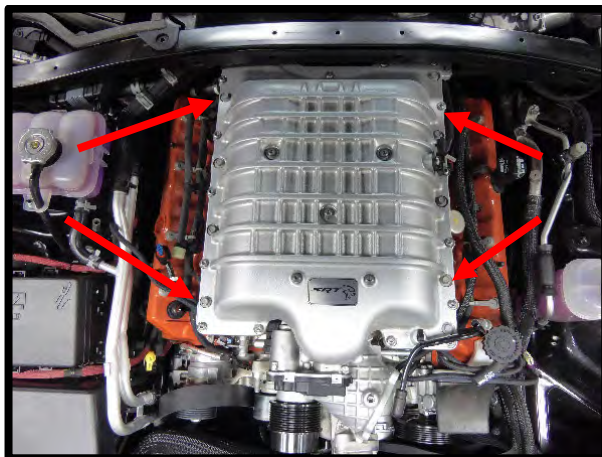

35. Clean the intake manifold surface, cover each port with tape.

36. Remove the fuel rail and injectors from supercharger assembly using a T30 torx.

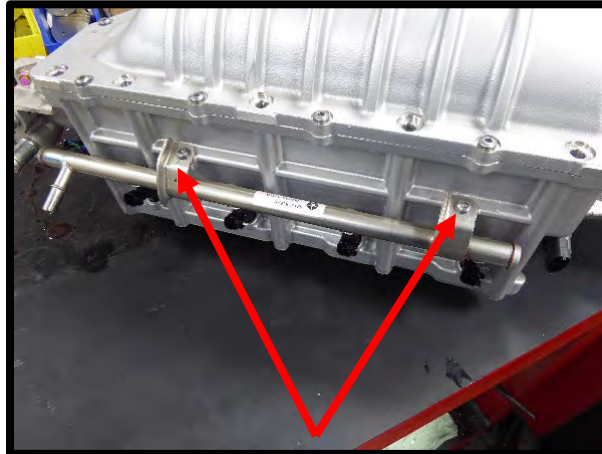

37. Using 5mm allen socket, remove the bolts securing lid to SC assembly. Lift lid from SC assembly and set aside for later installation.
38. Remove SIP sensor from the inlet of the supercharger using a T30 torx. Install the stock SIP TMAP sensor from the inlet of the supercharger to the new SC inlet. Secure using the supplied 6mm x 14mm HHFCS. Torque to 88 in-lbs using 10mm socket.

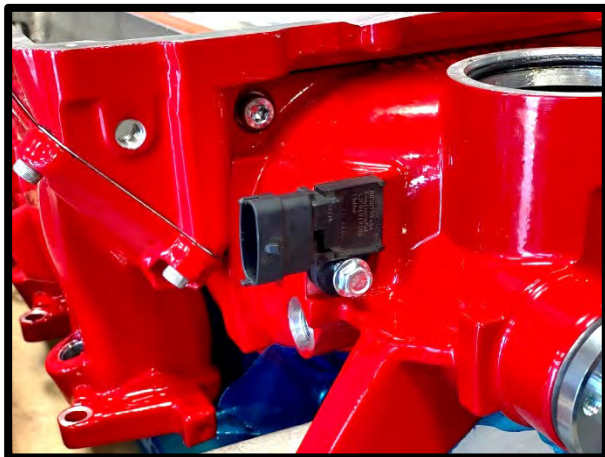
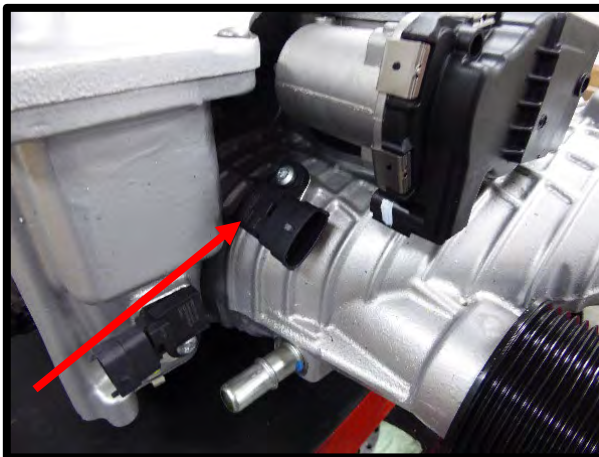

39. Remove both TMAP sensors from the passenger front and driver side rear of intake manifold using a T30 torx.

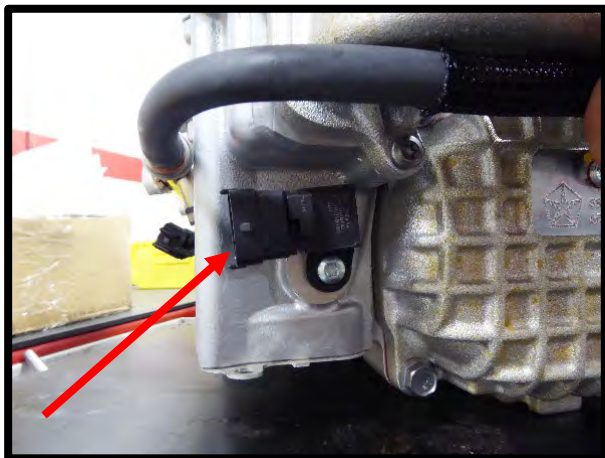
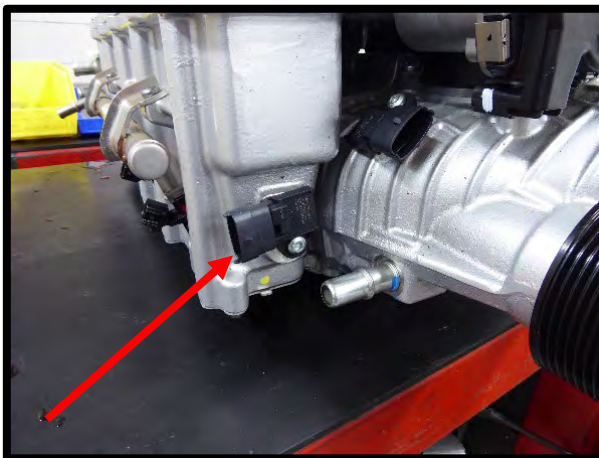

40. Install the post SC, post IC TMAP sensors (2) in the back of the manifold using the supplied 6mm x 14mm HHFCS, torque to 88 in-lbs using 10mm socket.

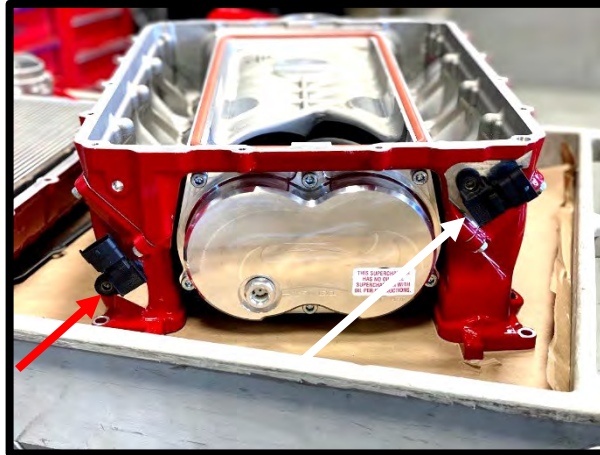

41. Remove the upper (intermediate) TMAP sensor from the factory lid, post SC, pre-IC using a T30 torx. Install the Post SC, pre IC TMAP to the SC lid as shown. Secure using the supplied 6mm x 14mm HHFCS. Torque to 88 in-lbs using 10mm socket.

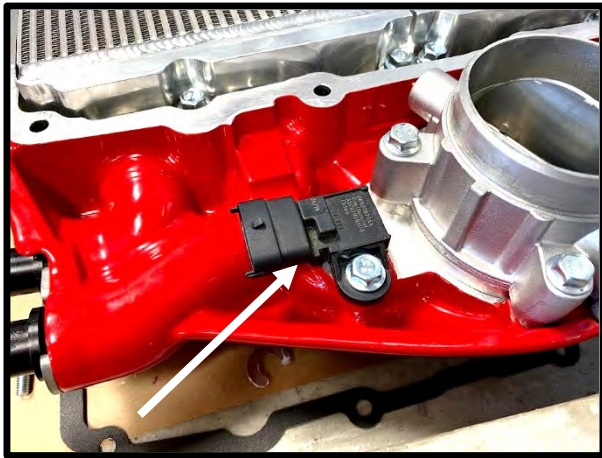
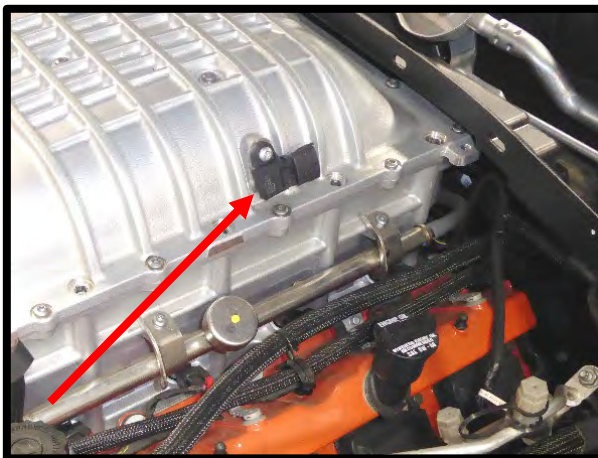

42. Remove the intercooler water temp sensor from the IC water cross over using a 19mm socket or wrench. Install the stock IC temp sensor, using light amount of thread sealant to the Whipple lid port.

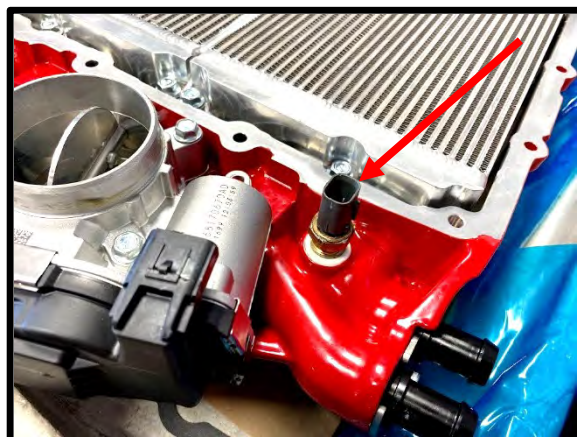
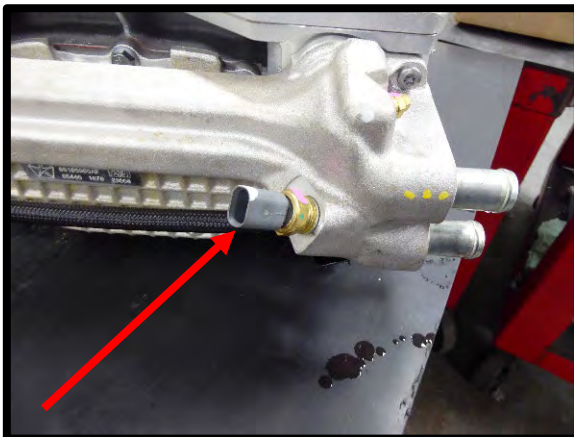

43. Install the supplied -6 ORB with oring to 15.82mm fitting to RH port on SC inlet. Use light amount of grease on oring for ease of installation.



44. Install the supplied -6 ORB with oring to 9.89mm fitting to LH port on SC inlet. Use light amount of grease on oring for ease of installation.

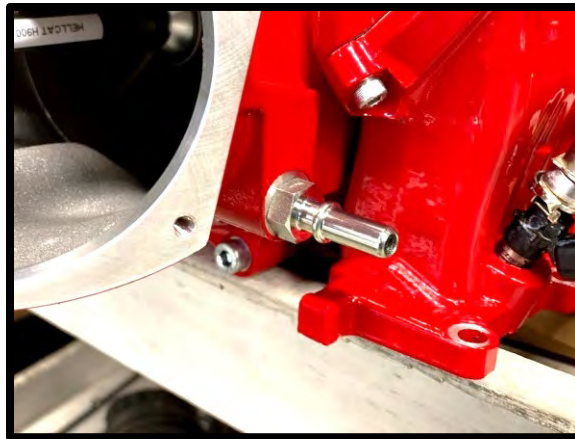

45. Install the supplied -6 ORB with oring to 3/8" barb fitting to LH top port on SC inlet. Use light amount of grease on oring for ease of installation.



46. Make sure the supercharger is on a flat surface. Remove the oil fill plug using an 8mm allen socket.
- Fill the compressor to the **MIDDLE** of the sight glass (**4.0 FL/OZ**). Rock compressor back and forth. Then spin compressor/rotors by the pulley so the oil fills the bearings. **NEVER OVER FILL THE SUPERCHARGER!**
 - Apply light amount of grease to oil fill plug oring, reinstall. Torque to 140 lbs-in.

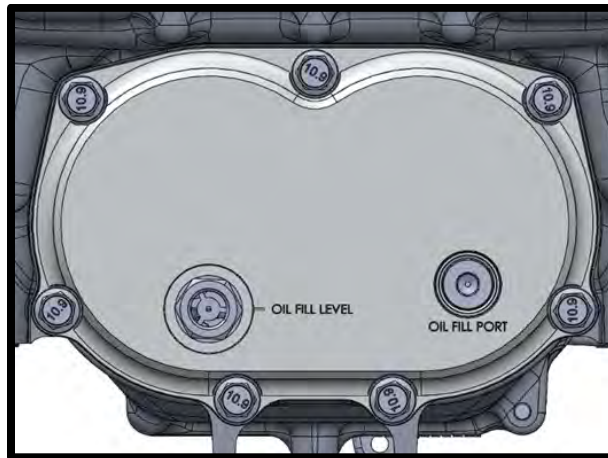

47. Using the supplied gasket set (**stock Hellcat or Cometic AFM ONLY**), install supercharger assembly to engine. Use the supplied (10x) 8mm x 30mm HHFCS bolts to locate SC in place. Lightly run bolts down hand tight **DO NOT TORQUE** at this time. **WARNING: DO NOT RUN PAPER GASKETS! STOCK OR WHIPPLE/COMETIC AFM TYPE GASKETS ONLY!**



48. Install the supplied (1x) 10mm x 25 SHCS bolt to front support. **Lightly torque to 42 in-lbs only to slide SC forward.**

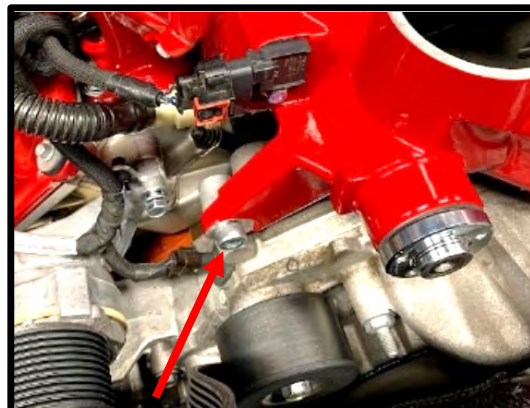

49. Using a 13mm socket, torque the supercharger assembly to cylinder heads in the following torque pattern, in the following sequence.
- First tighten all bolts, using the sequence, to **4 ft-lbs.**
 - Next tighten all bolts, using the sequence, to **11 ft-lbs.**
 - Final pass, using the sequence, to **16 ft-lbs.**

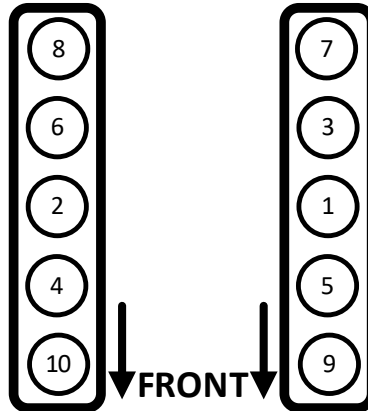

50. Install the supplied (1) 10mm x 25 SHCS bolt to front support. Lightly torque to 42 in-lbs only to slide SC forward.

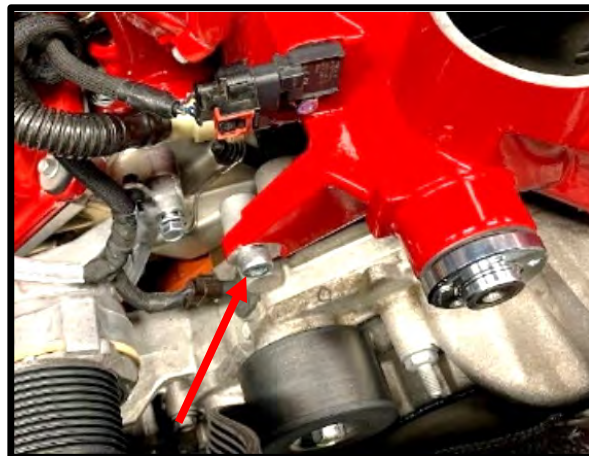

51. Torque the 10mm x 25mm HHFCS bolt you previously installed. Use a 16mm socket wrench. Torque to 30 ft-lbs.

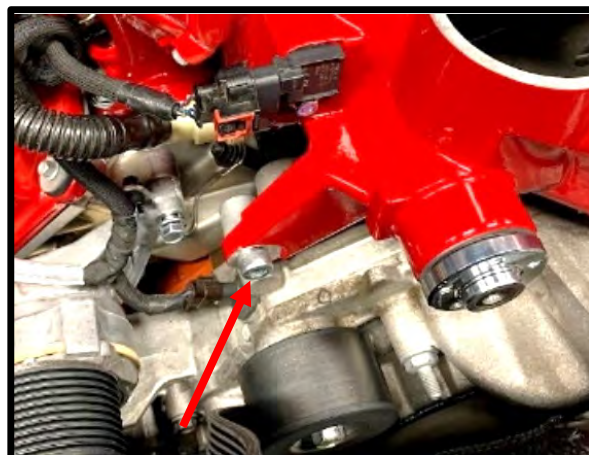

52. **(Stock fuel rails)** Test fit the stock rails to SC assembly, note that each rail needs 1 mounting bracket modified to clear bolt head. Grind small notch in bracket as required to clear.

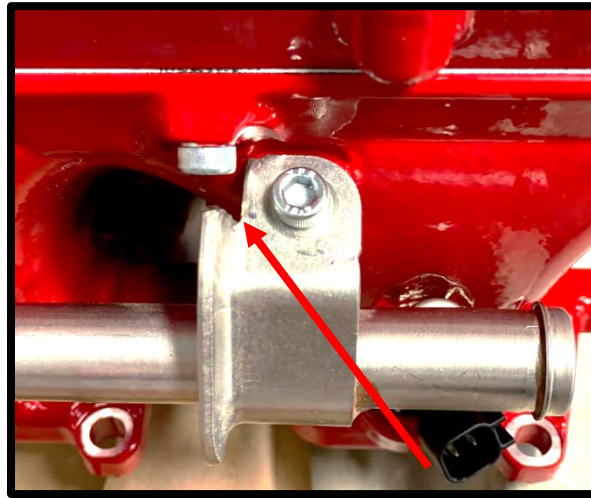

53. **(Stock fuel rails)** Transfer the stock fuel injectors to new supercharger assembly. Apply grease to both orings on injectors. Reinstall factory locking clip to rail and injector to secure to rail (***failure to do so could cause running issues**). Mount stock fuel rail to supercharger using supplied (4) 6mm x 14mm SHCS, apply light amount of **Blue Loctite #243** to threads. Torque to 88 in-lbs using 5mm allen socket.

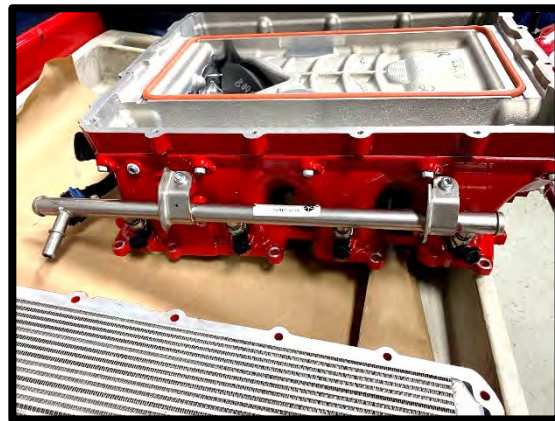

54. **(Billet fuel rails)** Transfer the stock fuel injectors to new supercharger assembly. Apply grease to both orings on injectors. Install supplied locking brackets to fuel injectors (***failure to do so will cause running issues**). Mount billet fuel rails to supercharger using supplied (4) 6mm x 35mm SHCS, apply light amount of **Blue Loctite #243** to threads (PN# YH06-WPL83-0054 is passenger side). Torque to 88 in-lbs using 5mm allen socket. ***NOTE:** For stock injectors only.



55. **(Billet fuel rails)** Install the (2) #2-115 Viton orings to male fitting. Apply grease to oring and slide through female fitting. Install (1) #3-908 Viton oring to fitting (shown with red arrow). Install fitting to the driver side fuel rail (rear). Install the supplied fuel PSI sensor to fuel rail adapter using (1) #2-011 oring. Reconnect fuel PSI sensor electrical connector.

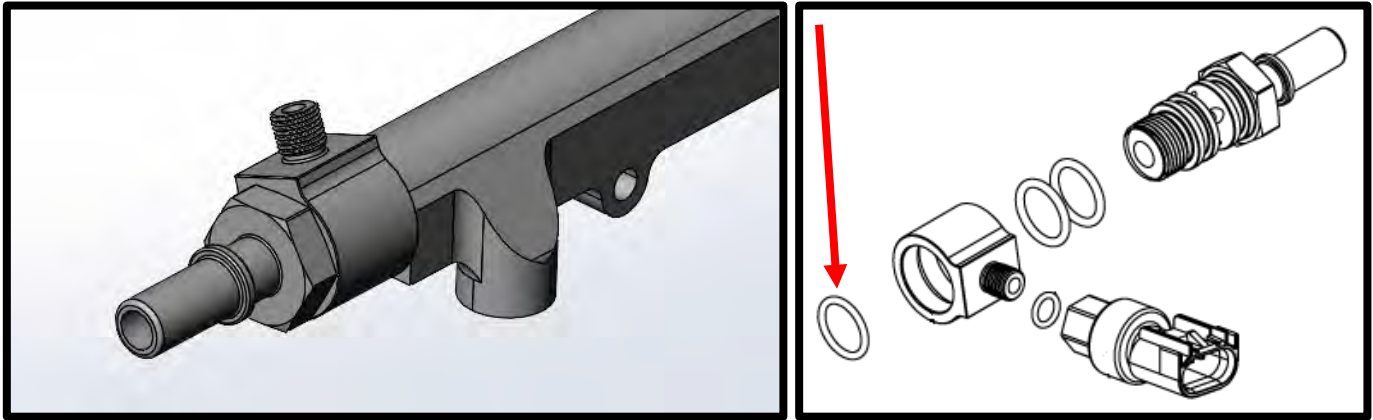

56. **(Billet fuel rails)** Install the (2) #2-115 Viton orings to male fitting. Apply grease to oring and slide through female fitting. Install (1) #3-908 Viton oring to fitting (shown with red arrow). Install banjo fitting to the longer fuel rail (PN# YH06-WPL83-0054). Use light amount of grease on oring. Install fitting to the RH side rear port.

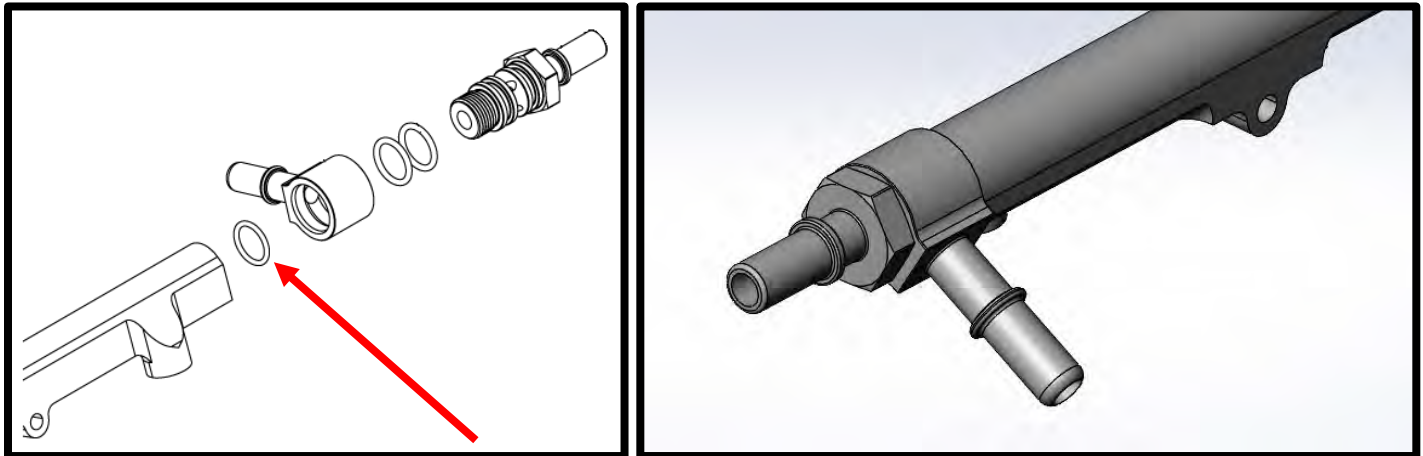

57. **(Billet fuel rails)** Install supplied -8 ORB plugs to front fuel rail ports, with #3-908 Viton oring. Use light amount of grease on oring. Install supplied 1/2" cross over hose at the rear fittings.

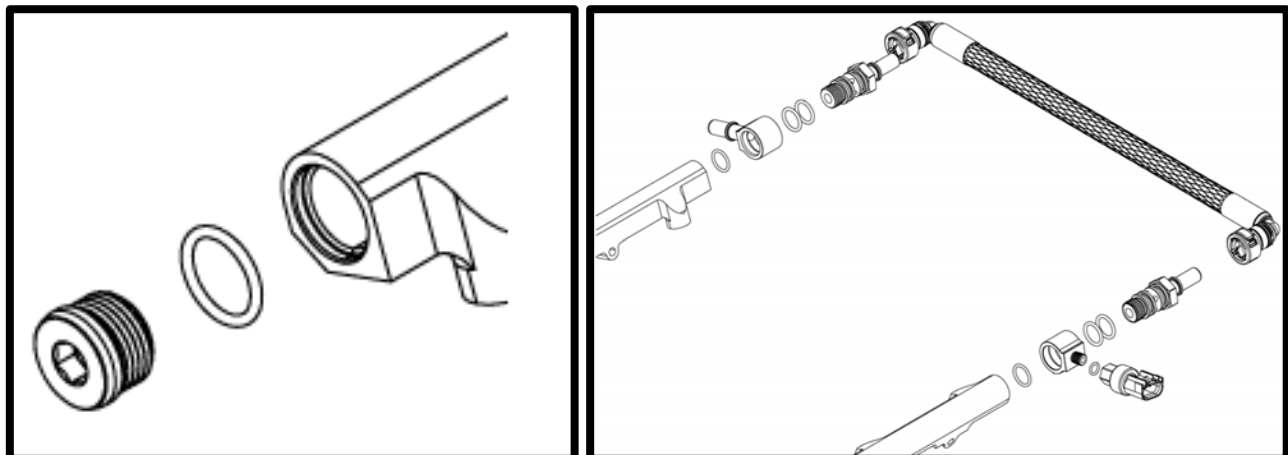

58. Install the supplied molded rubber oring to the supercharger oring groove.

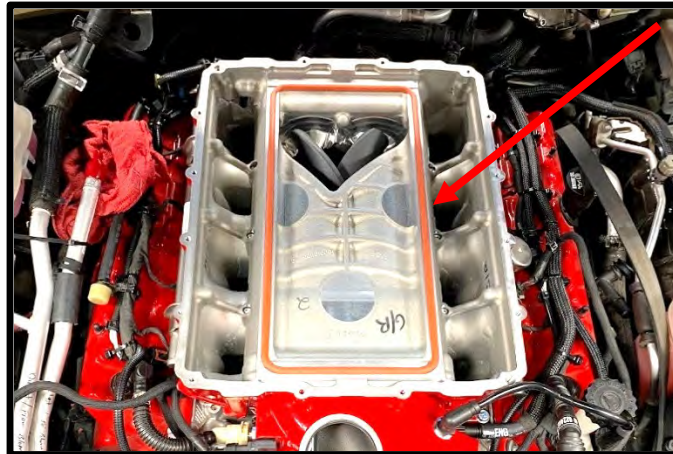

59. Remove the top bolt of the stock spring loaded tensioner. Install the idler bracket to the top fastener location of the spring-loaded tensioner using the supplied (1x) 8mm x 90mm SHCS and (1x) 8mm washer, hand tight. Secure bracket to pump using the supplied (1x) 10mm x 40mm SHCS and (1x) 10mm washer. Torque the 8mm bolt to 18 ft-lb and the 10mm to 26 ft-lb.

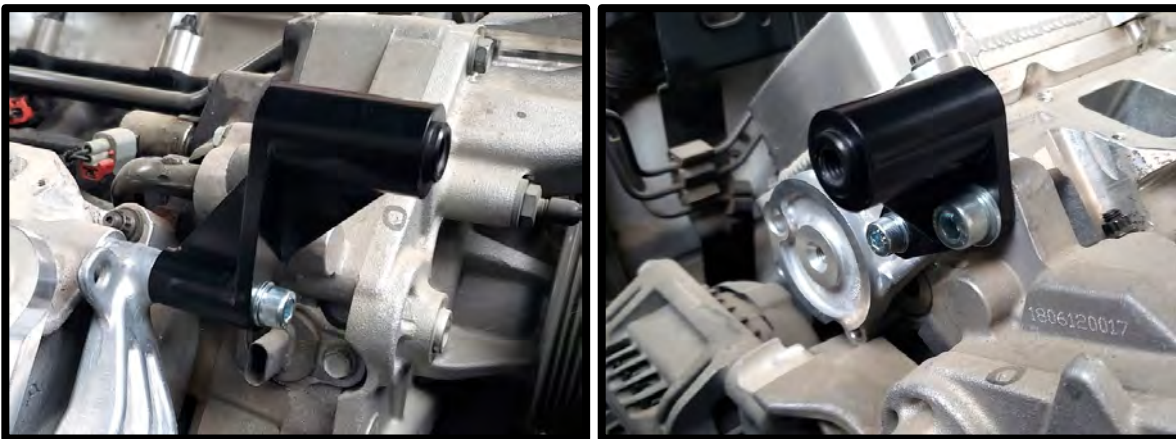

60. Install smooth 74mm supplied pulley to bracket using the step spacer and (1x) 10mm x 30mm HHFCS. Torque to 22 ft-lb.

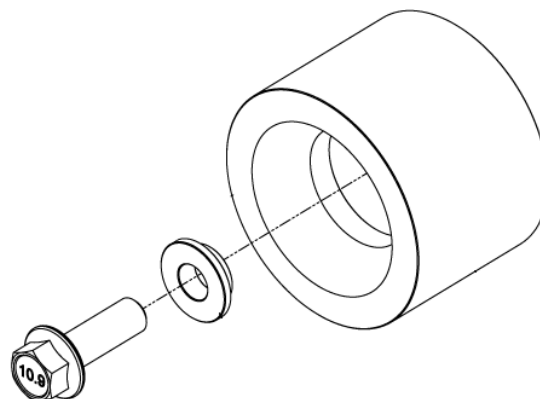

61. Install supercharger pulley using the supplied (5) 6mm x 14mm SHCS. Secure bolts hand tight. Install supplied SC belt in stock routing, by releasing tension on tensioner using a 13mm socket. Torque supercharger pulley bolts to 130 in-lbs using 5mm allen socket. **NOTE:** Aftermarket balancers and idlers will affect the belt lengths. Whipple only supplies parts for stock applications.

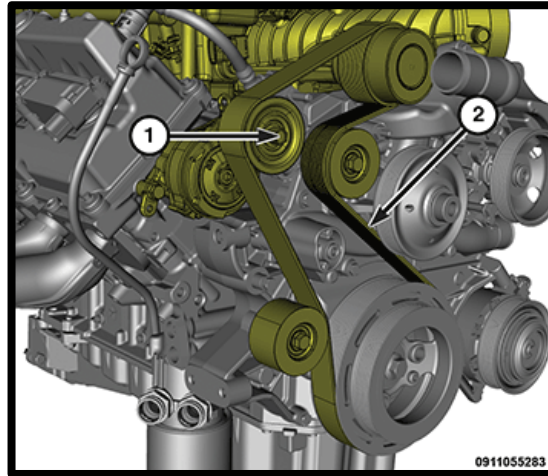

62. Install the stock EVAP hose, rubber 90deg to the 3/8" fitting you previously installed.



63. Connect the stock brake booster hose to the 9.89mm fitting previously installed. **NOTE:** Remove harness retainer from EVAP brake booster and EVAP lines.

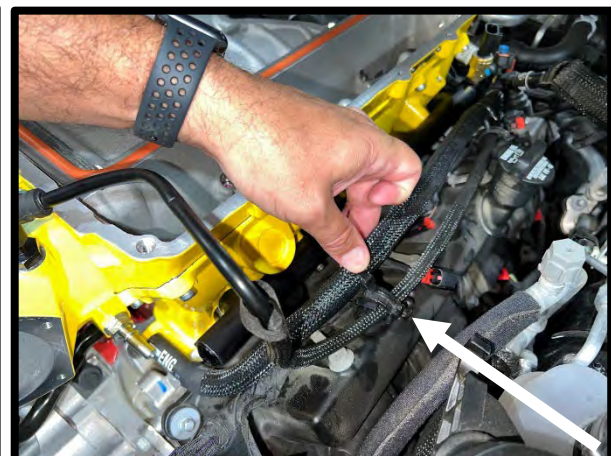

64. Connect the stock PCV hose to 15.82mm fitting previously installed.



65. Apply heavy amount of grease to bypass oring. Set supercharger to lid gasket on SC. Carefully set lid in place, apply pressure to front bypass to slide through oring (**NOTE:** You can see oring from inlet, ensure oring never drags or pinches). Using the (16) 6mm x 25mm SHCS, install all hand tight. Once all hand tight. Torque as followed:
- First pass, using the sequence, 75 in-lbs.
 - Second pass, using the sequence, 90 in-lbs.
 - Third pass, using the sequence, 112 in-lbs.

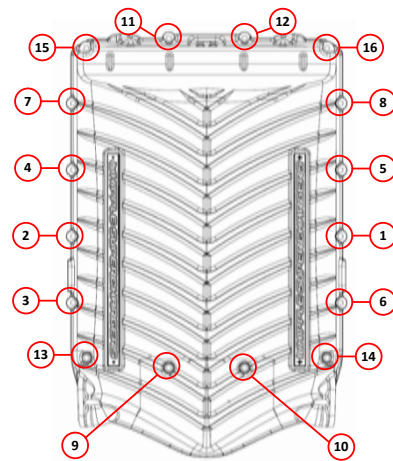

66. Connect the passenger side TMAP sensor connector (front passenger side of engine) pre-SC, inlet pressure sensor (#1) connector 4-way (1 = blue/green, 2= blue/tan, 3 = yellow/red, 4 = purple).



67. Install the supplied 22" MAP sensor extension to the passenger side (RH) MAP sensor connector (from front passenger side of engine) post SC, post IC (#4) connector 4-way (1 = blue/green, 2= blue/green, 3 = yellow/red, 4 = brown/blue). Route to the back of the intake manifold and connect to the passenger side (RH) TMAP sensor.

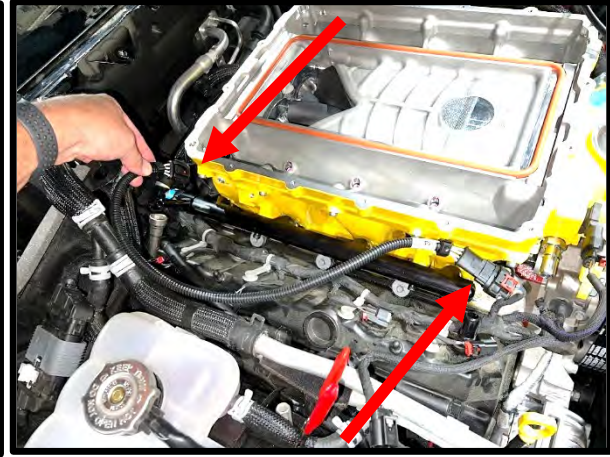

68. Lay supplied pigtail harness to LH/Driver side of supercharger. Connect the stock driver side stock TMAP sensor connector to pigtail. Plug in 3" pigtail to (LH) back of sc (back driver side of engine) post SC, post IC (#3) connector 4-way (1 =blue/green, 2 = blue/light blue, 3 = yellow/red, 4 = brown/pink). Connect female pigtail to stock to intermediate TMAP male connector. Connect end of pigtail to the (intermediate) TMAP sensor you previously installed to bottom of lid (next to bypass). **NOTE:** Remove all harness Christmas style harness retainers from TMAP and fuel psi sensor harness.

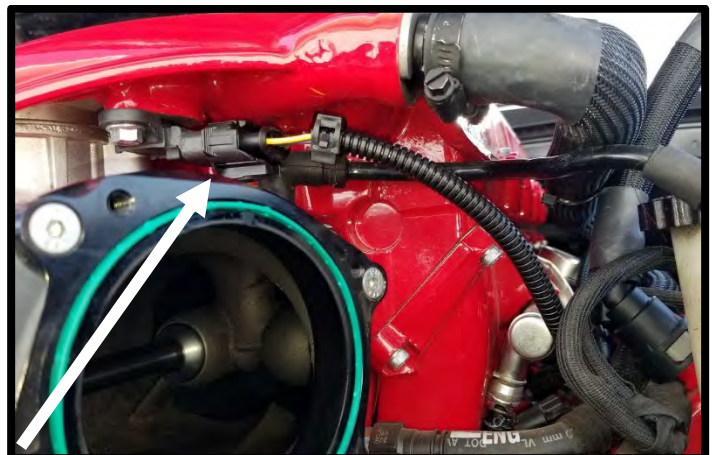
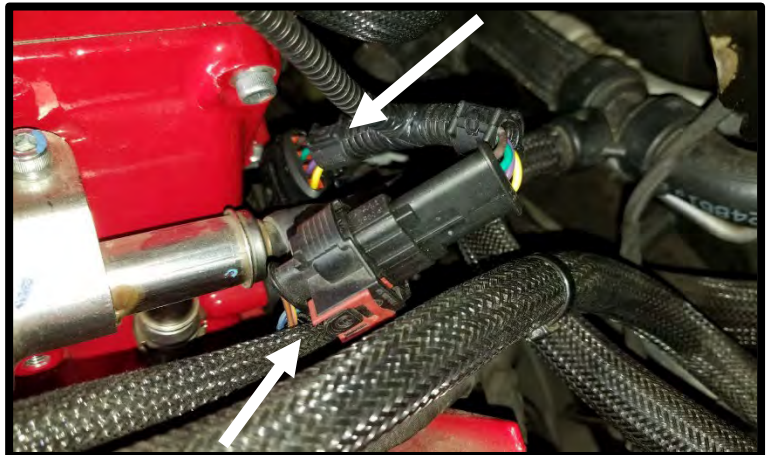

69. Install the supplied 22" IC temp sensor extension to stock 2-way connector by cutting the stock connector off 3" from end. Install pigtail using the supplied butt connectors, crimp together, then slide heat shrink over and shrink. Route to front of engine and connect to previously installed temp sensor.



70. Install the (4) 2-117 IC fitting orings to the (4) IC fittings. Apply grease to the (4) 2-117 IC fitting orings. Slide fittings into lid. Secure fittings with supplied fitting retainer bracket and 6mm x 12mm SHCS bolt. Torque to 80 in-lbs.

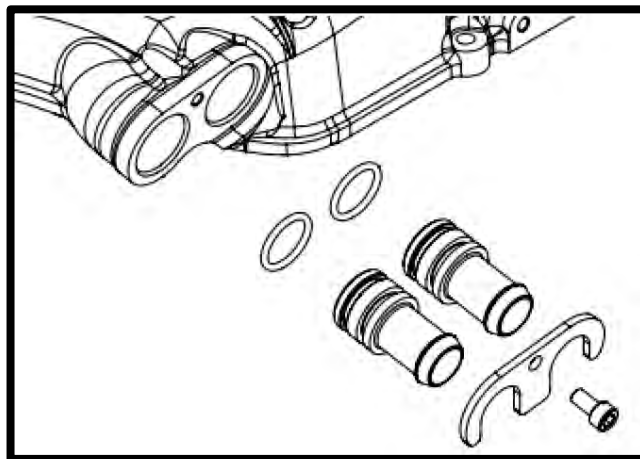

71. Assemble the intercooler hoses. For inlet (blue), take (2) of the #3103182 hose, face the short 90deg ends towards each other. Secure to tee fitting using supplied pinch clamps. Assemble hose #3103184 to tee fitting, secure with pinch clamp. For outlet (red), take (2) of the #3103182 hose, face the short 90deg ends towards each other. Secure to tee fitting using supplied pinch clamps. Assemble hose #3103183 to tee fitting, secure with pinch clamp.

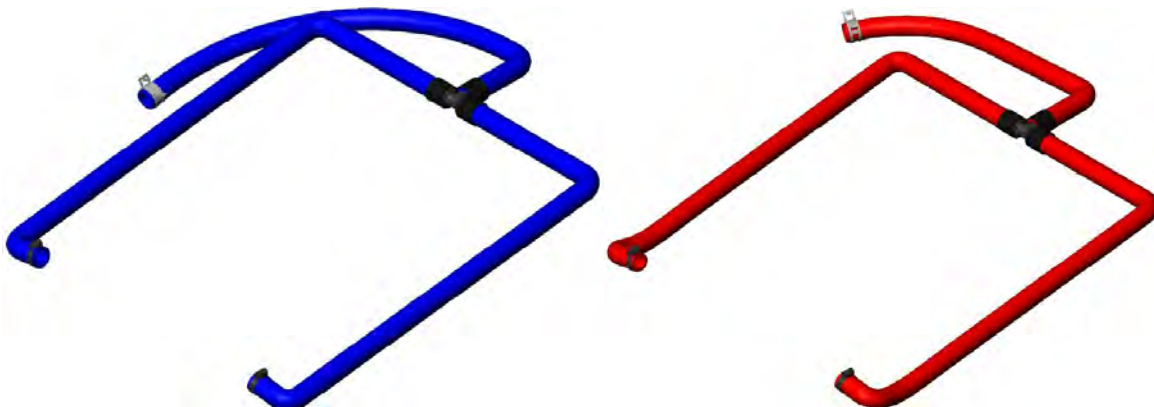

72. Install the supplied intercooler **inlet** 3/4" ID hose (#3103184) to the factory inlet aluminum tubing, connect to factory line using stock pinch clamp. Connect the (2) inlet hoses to the rear most fittings on each side of the supercharger lid. Secure with the supplied black worm clamps on both inlet fittings.

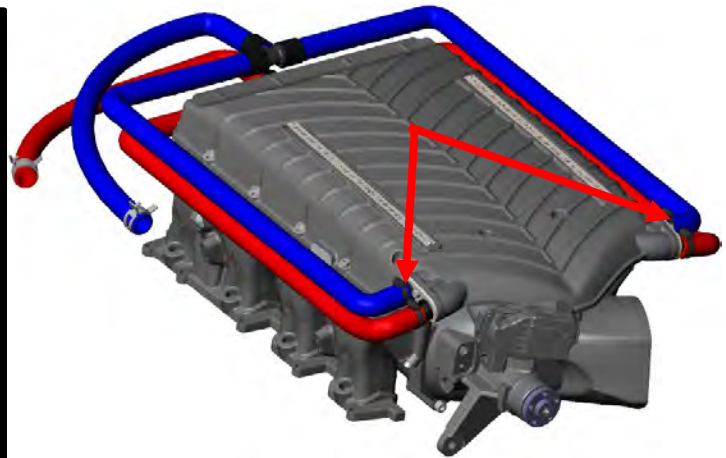
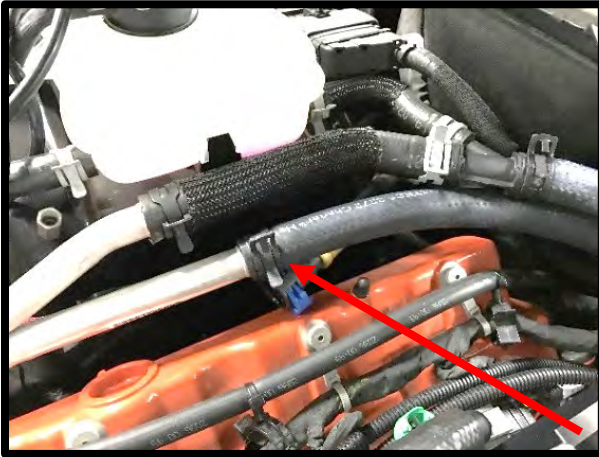

73. Install the supplied intercooler **outlet** 3/4" ID hose (#3103183) the factory Y fitting using stock pinch clamp. Connect the (2) outlet hoses to the forward most fittings on each side of the supercharger lid. Secure with the supplied worm clamps on both outlet fittings.

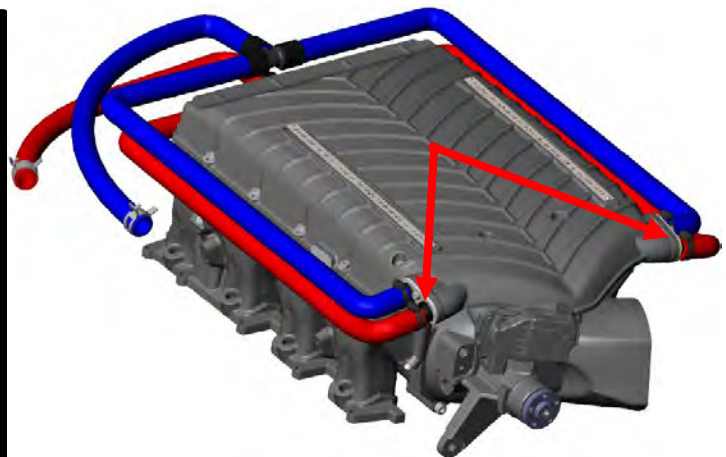

74. (**Stock throttle body**) Install the stock TB adapter to the supercharger inlet using the supplied TB adapter, supplied gasket and the (4) 6mm x 25mm FHCS. Torque to 75 in-lbs. Install the stock throttle body oring to TB adapter, then install the throttle body using the (4) 6mm x 35mm HHFCS bolts. Use **Blue Loctite #243** on threads, torque to 88 in-lbs using a 10mm socket.

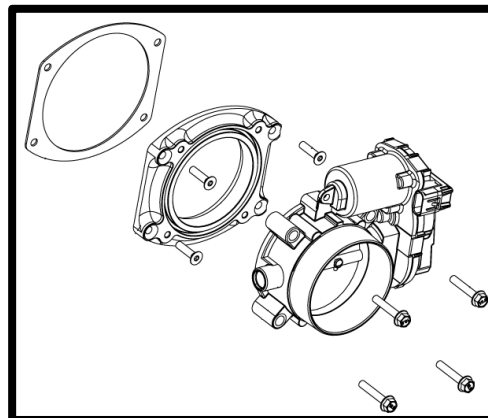
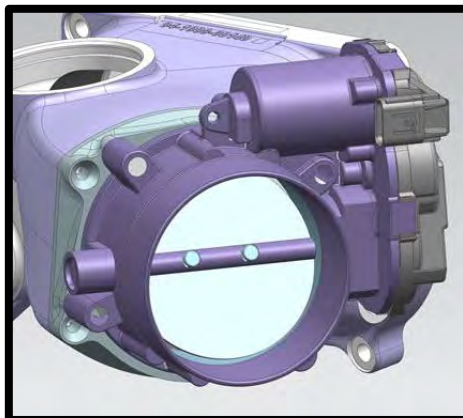

75. **(Billet throttle body)** Install supplied TB oring to TB, use light amount of grease to hold in place. Install the billet throttle body to the SC inlet using the (4) 6mm x 25mm SHCS bolts. Use **Blue Loctite #243** on threads, torque to 88 in-lbs using a 5mm allen socket.

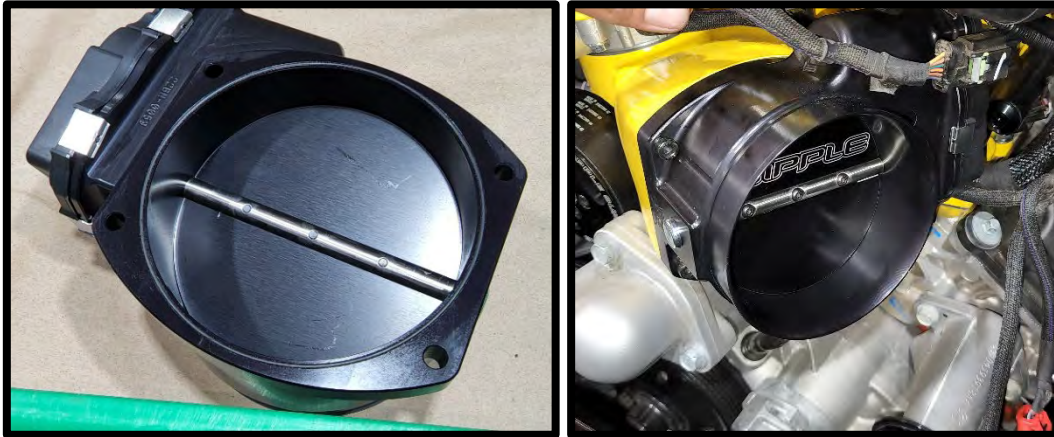

76. **(Stage 1)** Reconnect the throttle body 6-way connector. Reinstall Christmas tree retainer to secure harness.



77. **(MY2015-MY2016)** Install supplied 1.06" OD to .875" ID grommet into pre-existing hole in air inlet tube.



78. (MY2015-MY2016 Hellcat) Install the factory crank case pressure sensor assembly to the plastic air tube.



79. (MY2017+ Challenger/Charger) Install the MAF block off adapter using the (2) 4mm x 10mm SHCS.



80. (MY2017+ Challenger/Charger) Using a 13/16" hole saw, drill the air tube (drill point shown). Clean air tube and install supplied .80" OD to .50" ID rubber grommet. Install supplied 1/2" to 15.82mm quick connect fitting. Clean air tube from any debris.



81. (MY2017+ Challenger/Charger) Install the supplied 1.0625" OD to .75" ID rubber grommet. Install the stock IAT sensor into plastic adapter, twist and lock in position. Install IAT into air tube.



82. (2018 Trackhawk) Install supplied 1.0625" OD to .75" ID rubber grommet into air inlet tube. Install stock air temp sensor into supplied plastic adapter. Insert air inlet temp sensor into air tube.

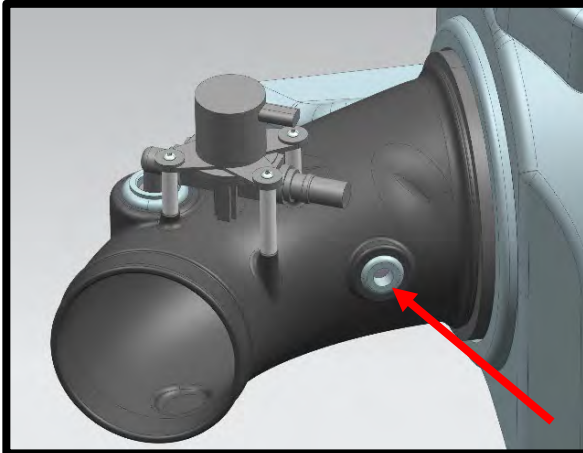

83. (2018 Trackhawk) Remove the 90deg plastic fitting from factory air inlet tube. Using a 1" hole saw, drill the supplied inlet air tube as shown. Install supplied 1.06" OD to .875" ID grommet into air tube. Install the 90deg PCV fitting to .875" grommet. Connect stock make up air hose with crank case pressure sensor.



84. (2019+ Trackhawk/Durango) Using a 1" hole saw, drill the air tube as shown. Install supplied 1.06" OD to .875" ID grommet into air tube. Install crank case pressure sensor to air tube, using the (2) 35mm and (1) 51mm spacers. Secure using (2) 4mm x 45mm and (1) 4mm x 65mm BHCS.



85. (2019+ Trackhawk/Durango) Install supplied 1.0625" OD to .75" ID rubber grommet into top port of air inlet tube. Install stock air temp sensor into supplied plastic adapter. Insert air inlet temp sensor into air tube.



86. (Redeye or when applicable) Install the stock headlight snorkel to the Whipple CAI box.



87. Install supplied rubber grommet to airbox from the inside. Install the supplied air tube, using a flat blade screwdriver to pull grommet lip away from air tube. Once in position, push edge of grommet into position. Install air filter to end and secure with stock clamp. Secure both ends of silicone hose couplers to air tube and throttle body. Secure airbox to factory mount with stock bolt.

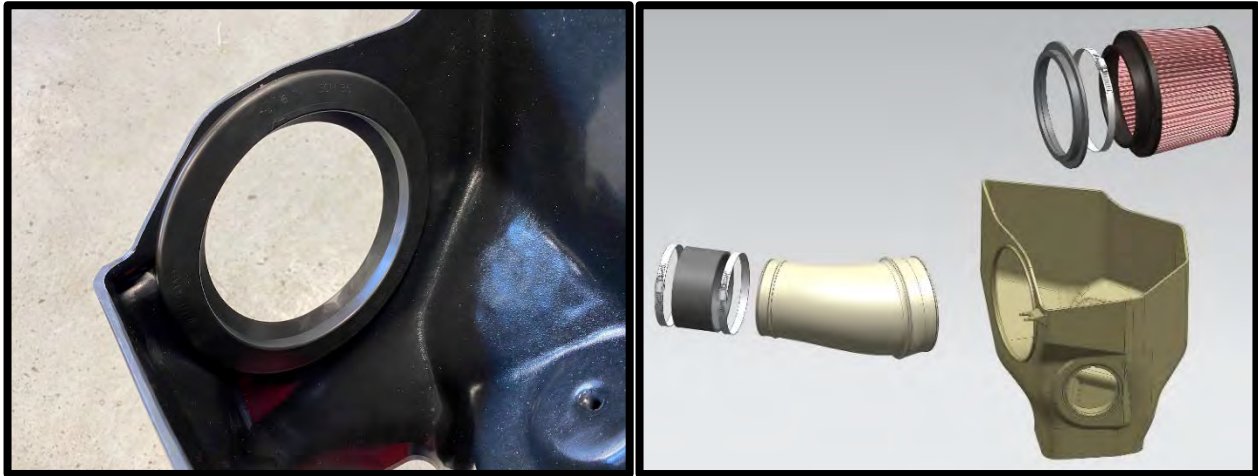

88. Mount the supplied airbox mounting bracket using the (2x) 5mm x 8mm BHCS. Secure using factory bolt through factory rubber grommet.

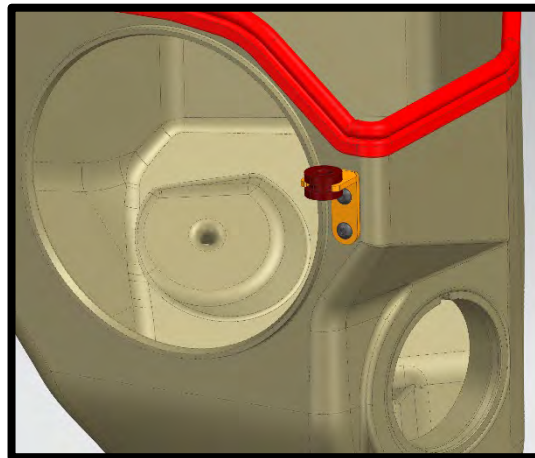

89. Connect air tube to throttle body using supplied silicone hose and supplied clamps.

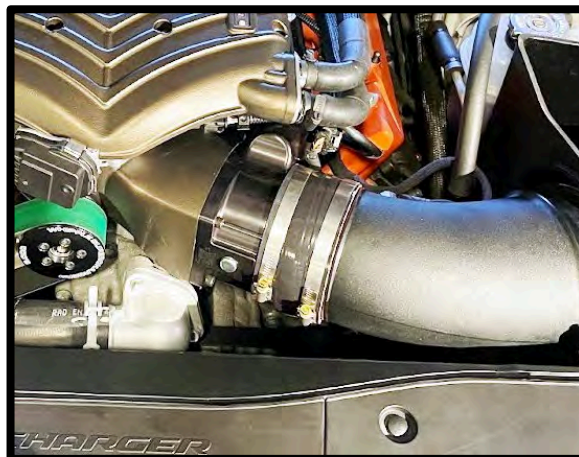

90. **(MY2015-MY2016)** Install factory MAF sensor element using the (2) 4mm x 10mm SHCS. Reconnect factory MAF connector to MAF sensor.



91. **(MY2015-MY2016 Hellcat)** Install the supplied ½" new make-up air hose. Connect 55deg fitting to factory valve cover barb and 90deg to sensor. Route around P/S reservoir and connect to air inlet tube.



92. **(MY2017+ Challenger/Charger)** Install supplied ½" to 15.82mm quick connect fitting into ½" grommet. Install supplied 5/8" x 12" hose from 45deg barb to stock barb.

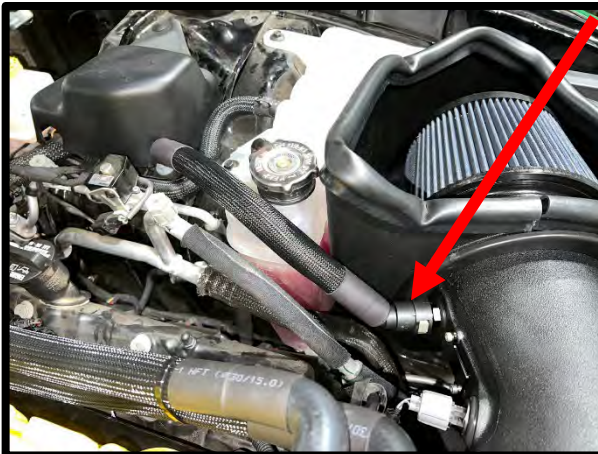

93. (2019+ Trackhawk/Durango) Install supplied 5/8" to 15.82mm 90deg quick connect fitting to make up air barb on valve cover. Install other end to crank case pressure sensor barb.

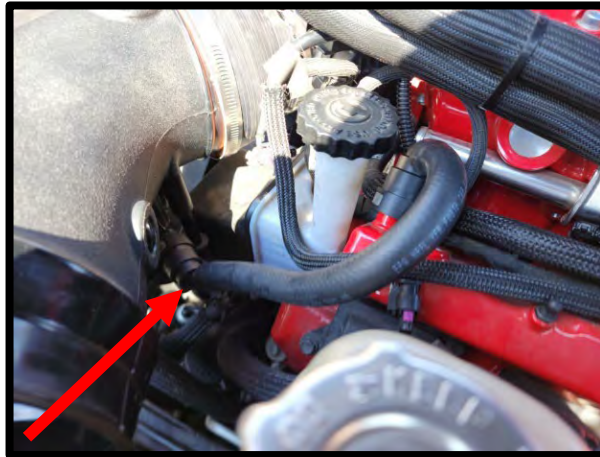

94. Install supplied airbox trim to top lip of airbox.



95. Reinstall the wiper motor assembly. Reinstall the plastic wiper motor assembly shielding.
96. Reinstall the (4) factory fasteners to the cowl cross brace using a 13mm socket (2 per side). Before tightening, push the brace back as far as possible for added supercharger clearance, 3mm clearance is required. If adequate clearance is not found (3mm), you will need to loosen the subframe mounts and push motor forward.

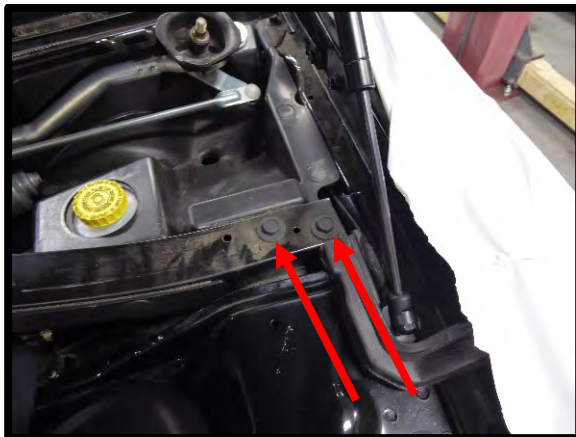
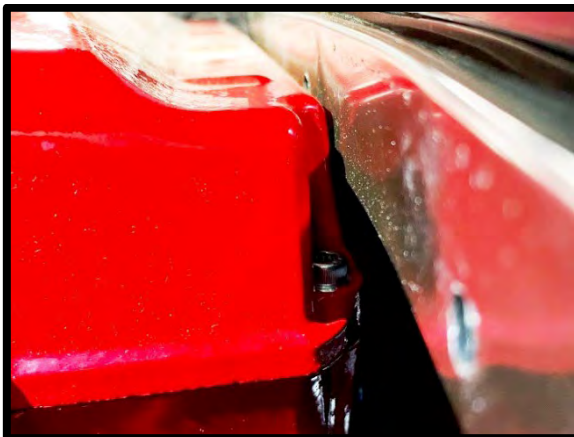

97. Reinstall the (6) push pins in the cowl cross brace. **NOTE:** Windshield wiper cover can be cut around supercharger to fit.



98. Reinstall the plastic cowling to the vehicle by installing the (8) push pins you previously removed. Make sure the tabs on each side lock in place.

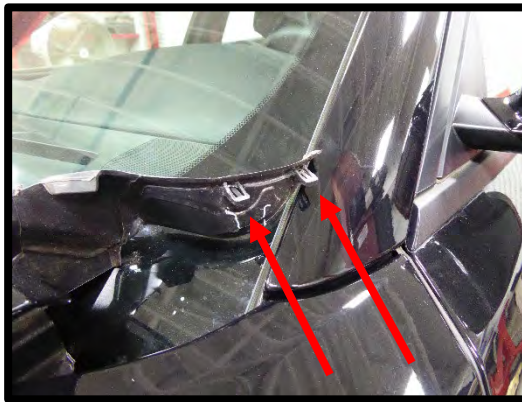
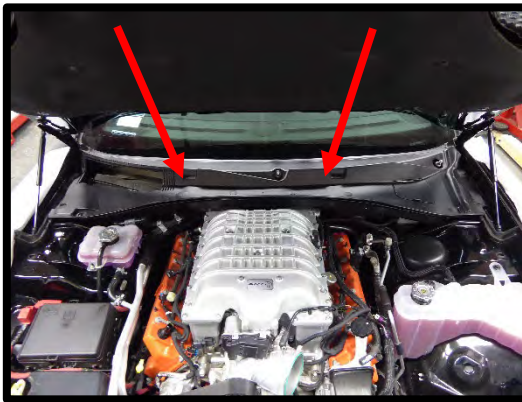

99. Reinstall the cabin air filter cover to the plastic cowling. Reinstall the windshield wipers using a 15mm socket. Use the factory (2) marks to center the wipers. Reinstall factory plastic cover.

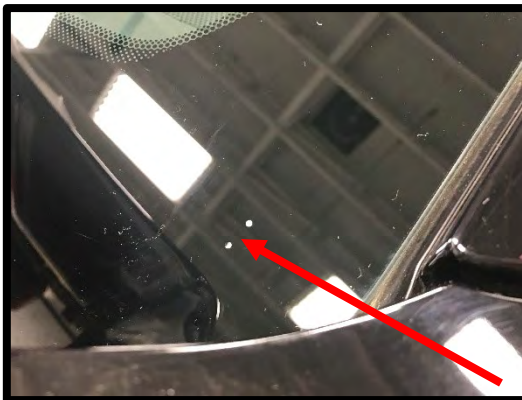

100. Attach the negative cable to the battery and tighten using a 10mm wrench.
101. Refill the intercooler reservoir with factory purple intercooler fluid #68163848AA and distilled water (50/50). **WARNING!! NEVER USE TAP WATER, THIS WILL CAUSE CORROSION IN THE SYSTEM.** 
102. Turn the Ignition key on, DO NOT START THE ENGINE (This will turn ON the fuel pump for 2 seconds). Inspect for fuel leaks, correct as required.

103. Start the vehicle or use a Tazer tool to toggle the intercooler pump to on. Fill the intercooler reservoir as needed. Squeeze the intercooler inlet/outlet lines at the same time, while the reservoir cap is off, to help burp the system. After 2 minutes of running, shut off and let cool, repeat at least 3 times prior to running engine with any load.
WARNING! Failure to burp properly could lead to engine damage.



104. Before driving, make SURE you have 91 [(RON+MON)/2] or higher-octane fuel in the system. NOT ½ tank of 89 and ½ tank of 91, ALL 91 or better fuel in the system.
105. If you would like to install a boost gauge, there is an extra 1/8" NPT port located on the driver side rear of the intake manifold.



106. Test drive vehicle for the first few miles under normal driving conditions, obey all traffic laws. Listen for any noises, vibrations, engine misfire, detonation/pinging or anything that does not seem normal. The supercharger does have a slight whining noise under boost conditions, which is normal.
107. Re-check the intercooler reservoir coolant level regularly over the first 1,000 miles, top off level as needed.
108. Re-check SC oil level regularly over the first 1,000 miles, level may drop very slightly as it fills the bearings and cavities.
109. After the initial test drive, go through the belt tensioner process again. During your second test drive, gradually work the vehicle to wide open throttle runs. Listen for any engine detonation (pinging). If engine detonation is present, let up on the throttle immediately.
110. If you have questions about your vehicle's performance, please check with your installation facility or call Whipple Superchargers at 559.442.1261, Monday through Friday from 8am to 5:00pm, Pacific Time or email questions to tech@whipplesuperchargers.com. Whipple does not offer custom tuning for modified engines.

MAINTENANCE AND SERVICE

Be sure to follow the maintenance and service recommendations below to optimize the life and performance of your Whipple-supercharged vehicle.

1. Use only premium grade fuel (91-octane or higher), 93 octane is always preferred. $(RON+MON)/2$ is the US spec on fuel.
2. Always listen for any sign of spark knock or pinging. If present, discontinue use immediately and consult your vehicle owner's manual.
3. Do not operate the vehicle at large throttle opening if the MIL lamp is on steadily. This indicates an electronic engine control malfunction: reduce throttle opening and consult your vehicle dealer.
4. Check the supercharger oil level at every engine oil change. Add Whipple SC oil to the supercharger if required. Change the oil in the supercharger every 50,000 miles. Use Whipple SC approved oil only. **NEVER OVER FILL SC, SEVERE DAMAGE WILL OCCUR!**
5. Inspect and clean your high-flow air filter element every 7,500 miles, replace as necessary.
6. Follow your factory service intervals for oil changes and other typical maintenance items.
7. Check the supercharger and accessory drive belts. Adjust or replace as required.

CONGRATULATIONS

Your new Whipple Supercharger is engineered to significantly increase your engines power across a broad range of RPM's. It is Whipple's goal to improve your driving experience for many miles and years to come.

Whipple Superchargers operate as an air pump and contain internal rotors that are driven by the engine's crankshaft and serpentine belts. The supercharger compresses outside air and channels it into the engine's intake ports. Because of their design, superchargers may generate some additional noise over the standard, normally aspirated induction system.

At idle, you may hear a medium-pitch rattle from the supercharger main housing. This will diminish at about 400-500 rpm above idle.

You may also experience a muffled high-pitched whine during acceleration. This is caused by the pumping action of the supercharger compressing air and only occurs during boost conditions. It is inaudible during part-throttle acceleration.

These are normal noises associated with any supercharger and have no effect on supercharger performance or engine durability.

Your supercharger is warranted by Whipple Superchargers, please see your terms and conditions on the back of your invoice for more information in regards to the limited warranty. NOTE: Whipple Superchargers will not authorize any warranty repair work or supercharger replacement for normal noise.

